



FCC RF Test Report

APPLICANT : Magne AI Global tech limited
EQUIPMENT : MAG1
BRAND NAME : MaQ
MODEL NAME : MA1
FCC ID : 2BVCPGC603606
STANDARD : 47 CFR Part 22(H), 24(E), 27(L)
CLASSIFICATION : PCS Licensed Transmitter Held to Ear (PCE)
TEST DATE(S) : Feb. 26, 2026 ~ Mar. 15, 2026

We, Sporton International Inc. (Kunshan), would like to declare that the tested sample has been evaluated in accordance with the procedures given in ANSI C63.26-2015 and shown compliance with the applicable technical standards.

The test results in this report apply exclusively to the tested model / sample. Without written approval of Sporton International Inc. (Kunshan), the test report shall not be reproduced except in full.

Jason Jia



Approved by: Jason Jia

Sporton International Inc. (Kunshan)

**No. 1098, Pengxi North Road, Kunshan Economic Development Zone Jiangsu Province 215300
People's Republic of China**



TABLE OF CONTENTS

REVISION HISTORY..... 3

SUMMARY OF TEST RESULT 4

1 GENERAL DESCRIPTION 5

1.1 Applicant..... 5

1.2 Manufacturer 5

1.3 Product Feature of Equipment Under Test 5

1.4 Product Specification of Equipment Under Test 6

1.5 Modification of EUT 6

1.6 Maximum ERP/EIRP Power, and Emission Designator 7

1.7 Testing Location 7

1.8 Test Software 7

1.9 Applicable Standards 8

2 TEST CONFIGURATION OF EQUIPMENT UNDER TEST 9

2.1 Test Mode..... 9

2.2 Connection Diagram of Test System 10

2.3 Support Unit used in test configuration 10

2.4 Measurement Results Explanation Example 11

2.5 Frequency List of Low/Middle/High Channels..... 11

3 CONDUCTED TEST RESULT..... 12

3.1 Measuring Instruments..... 12

3.2 Test Setup 12

3.3 Test Result of Conducted Test..... 12

3.4 Conducted Output Power and ERP/EIRP 13

3.5 Peak-to-Average Ratio 14

3.6 99% Occupied Bandwidth and 26dB Bandwidth Measurement..... 15

3.7 Conducted Band Edge 16

3.8 Conducted Spurious Emission 17

3.9 Frequency Stability..... 18

4 RADIATED TEST ITEMS 19

4.1 Measuring Instruments..... 19

4.2 Test Setup 19

4.3 Test Result of Radiated Test..... 20

4.4 Field Strength of Spurious Radiation Measurement 21

5 LIST OF MEASURING EQUIPMENT 22

6 MEASUREMENT UNCERTAINTY 23

APPENDIX A. TEST RESULTS OF CONDUCTED TEST

APPENDIX B. TEST RESULTS OF RADIATED TEST

APPENDIX C. TEST SETUP PHOTOGRAPHS



SUMMARY OF TEST RESULT

Report Section	FCC Rule	Description	Limit	Result	Remark
3.4	§2.1046	Conducted Output Power	-	Report Only	-
	§22.913(a)(5)	Effective Radiated Power	< 7 Watts	PASS	-
	§24.232(c)	Equivalent Isotropic Radiated Power	< 2 Watts	PASS	-
	§27.50(d)(4)	Equivalent Isotropic Radiated Power	< 1 Watts	PASS	-
3.5	§24.232(d)	Peak-to-Average Ratio	< 13 dB	PASS	-
3.6	§2.1049	Occupied Bandwidth	Reporting Only	PASS	-
3.7	§2.1051 §22.917(a) §24.238(a) §27.53(h)	Band Edge Measurement	< 43+10log10(P[Watts])	PASS	-
3.8	§2.1051 §22.917(a) §24.238(a) §27.53(h)	Conducted Emission	< 43+10log10(P[Watts])	PASS	-
3.9	§2.1055 §22.355	Frequency Stability for Temperature & Voltage	< 2.5 ppm for Part 22	PASS	-
	§2.1055 §24.235 §27.54		Within Authorized Band		
4.4	§2.1053; §22.917(a); §24.238(a); §27.53(h)	Field Strength of Spurious Radiation	< 43+10log10(P[Watts])	PASS	Under limit 28.05 dB at 9405.00 MHz

Conformity Assessment Condition:

1. The test results (PASS/FAIL) with all measurement uncertainty excluded are presented against the regulation limits or in accordance with the requirements stipulated by the applicant/manufacturer who shall bear all the risks of non-compliance that may potentially occur if measurement uncertainty is taken into account.
2. The measurement uncertainty please refer to each test result in the section "Measurement Uncertainty"

Disclaimer:

The product specifications of the EUT presented in the test report that may affect the test assessments are declared by the manufacturer who shall take full responsibility for the authenticity.



1 General Description

1.1 Applicant

Magne AI Global tech limited

FLAT 1019B,10/F,LIVEN HOUSE,NO.61-63 KING YIP STREET KWUN TONG HK

1.2 Manufacturer

FIH Precision Electronics(Lang Fang)Co.,Ltd.

No. 18 Furao Road, Longhe High tech Industrial Development Zone, Anci District, Langfang City, Hebei Province

1.3 Product Feature of Equipment Under Test

Product Feature	
Equipment	MAG1
Brand Name	MaQ
Model Name	MA1
FCC ID	2BVCPGC603606
IMEI Code	Conducted: 016813000002111/016813000002129 Radiation: 016813000003457
EUT Stage	Production Unit

Remark: The above EUT's information was declared by manufacturer. Please refer to the specifications or user's manual for more detailed description.

1.4 Product Specification of Equipment Under Test

Standards-related Product Specification	
Tx Frequency	GSM/GPRS: 850: 824 MHz ~ 849 MHz 1900: 1850MHz ~ 1910MHz WCDMA: Band V: 824 MHz ~ 849 MHz Band II: 1850 MHz ~ 1910 MHz Band IV: 1710 MHz ~ 1755 MHz
Rx Frequency	GSM/GPRS: 850: 869 MHz ~ 894 MHz 1900: 1930 MHz ~ 1990 MHz WCDMA: Band V: 869 MHz ~ 894 MHz Band II: 1930 MHz ~ 1990 MHz Band IV: 2110 MHz ~ 2155 MHz
Maximum Output Power to Antenna	GSM/GPRS: 850: 32.40 dBm 1900: 28.60 dBm WCDMA: Band V: 22.15 dBm Band II: 22.22 dBm Band IV: 22.32 dBm
Antenna Type	LDS Antenna
Antenna Gain	Cellular Band: -4 dBi PCS Band: -3 dBi AWS Band: -4 dBi
Type of Modulation	GSM: GMSK GPRS: GMSK WCDMA: BPSK HSDPA: QPSK HSUPA: QPSK HSPA+ : 16QAM

1.5 Modification of EUT

No modifications are made to the EUT during all test items.



1.6 Maximum ERP/EIRP Power, and Emission Designator

FCC Rule	Frequency Band	Frequency Range (MHz)	Type of Modulation	Maximum ERP/EIRP (W)	Emission Designator
Part 22	GSM850 (GPRS)	824.2 ~ 848.8	GMSK	0.4217	241KGXW
Part 22	WCDMA Band V	826.4 ~ 846.6	BPSK	0.0398	4M15F9W
Part 24	GSM1900 (GPRS)	1850.2 ~ 1909.8	GMSK	0.3631	240KGXW
Part 24	WCDMA Band II	1852.4 ~ 1907.6	BPSK	0.0836	4M15F9W
Part 27	WCDMA Band IV	1712.4 ~ 1752.6	BPSK	0.0687	4M15F9W

1.7 Testing Location

Sporton International Inc. (Kunshan) is accredited to ISO/IEC 17025:2017 by American Association for Laboratory Accreditation with Certificate Number 5145.02.

Test Firm	Sporton International Inc. (Kunshan)		
Test Site Location	No. 1098, Pengxi North Road, Kunshan Economic Development Zone Jiangsu Province 215300 People’s Republic of China TEL : +86-512-57900158		
Test Site No.	Sporton Site No.	FCC Designation No.	FCC Test Firm Registration No.
	03CH04-KS TH01-KS	CN1257	314309

1.8 Test Software

Item	Site	Manufacturer	Name	Version
1.	TH01-KS	SPORTON	Part2224_Ver5.0 200330	5.0
2.	03CH04-KS	AUDIX	E3	210616



1.9 Applicable Standards

According to the specifications of the manufacturer, the EUT must comply with the requirements of the following standards:

- ♦ 47 CFR Part 22(H), 24(E), 27(L)
- ♦ ANSI C63.26-2015
- ♦ FCC KDB 971168 D01 Power Meas. License Digital Systems v03r01
- ♦ FCC KDB 412172 D01 Determining ERP and EIRP v01r01

Remark:

1. All test items were verified and recorded according to the standards and without any deviation during the test.
2. This EUT has also been tested and complied with the requirements of FCC Part 15, Subpart B, recorded in a separate test report.



2 Test Configuration of Equipment Under Test

2.1 Test Mode

Antenna port conducted and radiated test items were performed according to KDB 971168 D01 Power Meas. License Digital Systems v03r01 with maximum output power.

Radiated measurements were performed with rotating EUT in different three orthogonal test planes to find the maximum emission.

Radiated emissions were investigated as following frequency range:

1. 30 MHz to 9000 MHz for GSM850 and WCDMA Band V.
2. 30 MHz to 18000 MHz for WCDMA Band IV.
3. 30 MHz to 19100 MHz for GSM1900 and WCDMA Band II.

All modes and data rates and positions were investigated.

Test modes are chosen to be reported as the worst case configuration below:

Test Modes		
Band	Radiated TCs	Conducted TCs
GSM 850	■ GPRS 1 Tx slots Link	■ GPRS 1 Tx slots Link
GSM 1900	■ GPRS 1 Tx slots Link	■ GPRS 1 Tx slots Link
WCDMA Band V	■ RMC 12.2Kbps Link	■ RMC 12.2Kbps Link
WCDMA Band II	■ RMC 12.2Kbps Link	■ RMC 12.2Kbps Link
WCDMA Band IV	■ RMC 12.2Kbps Link	■ RMC 12.2Kbps Link

2.2 Connection Diagram of Test System

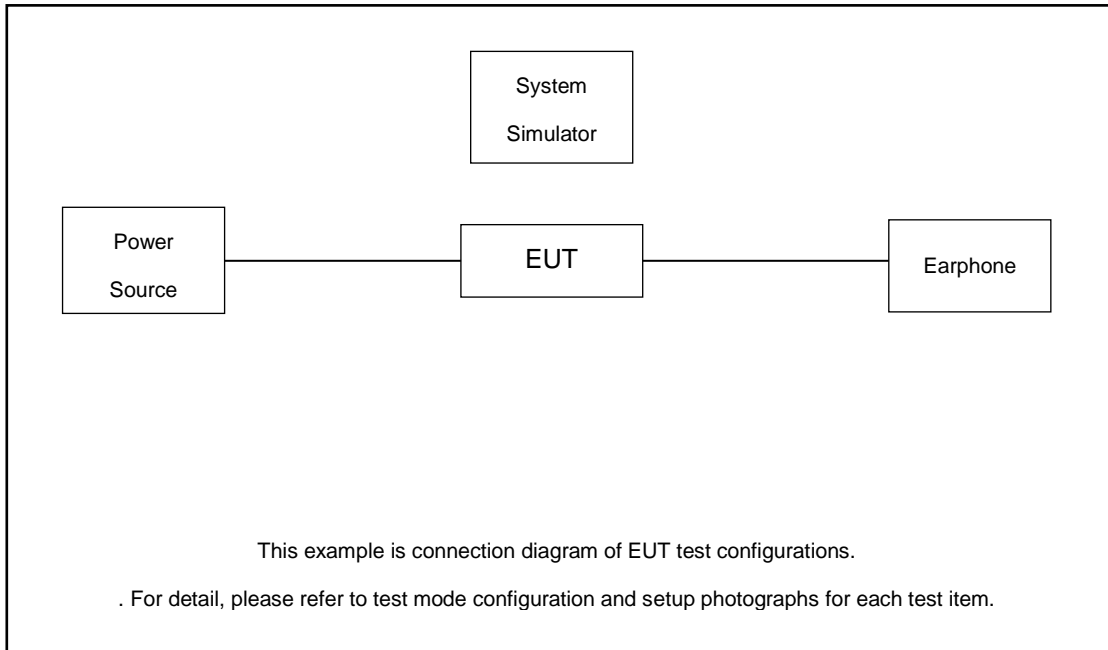

The EUT has been configuration operated in a manner tended to maximize its emission characteristics in a typical application.

2.3 Support Unit used in test configuration

Item	Equipment	Trade Name	Model No.	FCC ID	Data Cable	Power Cord
1.	System Simulator	R&S	CMU 200	N/A	N/A	Unshielded, 1.8 m
2.	System Simulator	Agilent	E5515C	N/A	N/A	Unshielded, 1.8 m
3.	Earphone	N/A	N/A	N/A	N/A	N/A



2.4 Measurement Results Explanation Example

For all conducted test items:

The offset level is set in the spectrum analyzer to compensate the RF cable loss and attenuator factor between RF conducted output port and spectrum analyzer. With the offset compensation, the spectrum analyzer reading level will be exactly the RF output level.

The spectrum analyzer offset is derived from RF cable loss and attenuator factor.

$$\text{Offset} = \text{RF cable loss} + \text{attenuator factor}.$$

The following shows an offset computation example with RF cable loss 5.4 dB and a 10dB attenuator.

Example :

$$\begin{aligned} \text{Offset(dB)} &= \text{RF cable loss(dB)} + \text{attenuator factor(dB)}. \\ &= 5.4 + 10 = 15.4 \text{ (dB)} \end{aligned}$$

2.5 Frequency List of Low/Middle/High Channels

Frequency List				
Band	Channel/Frequency(MHz)	Lowest	Middle	Highest
GSM850	Channel	128	189	251
	Frequency	824.2	836.4	848.8
WCDMA Band V	Channel	4132	4182	4233
	Frequency	826.4	836.4	846.6
GSM1900	Channel	512	661	810
	Frequency	1850.2	1880.0	1909.8
WCDMA Band II	Channel	9262	9400	9538
	Frequency	1852.4	1880.0	1907.6
WCDMA Band IV	Channel	1312	1413	1513
	Frequency	1712.4	1732.6	1752.6

3 Conducted Test Result

3.1 Measuring Instruments

See list of measuring instruments of this test report.

3.2 Test Setup

3.2.1 Conducted Output Power

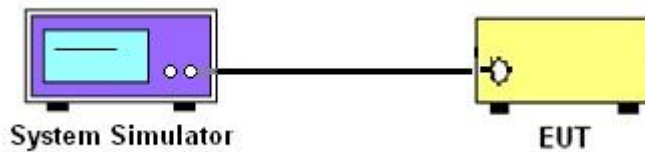

3.2.2 Peak-to-Average Ratio, Occupied Bandwidth, Conducted Band-Edge and Conducted Spurious Emission

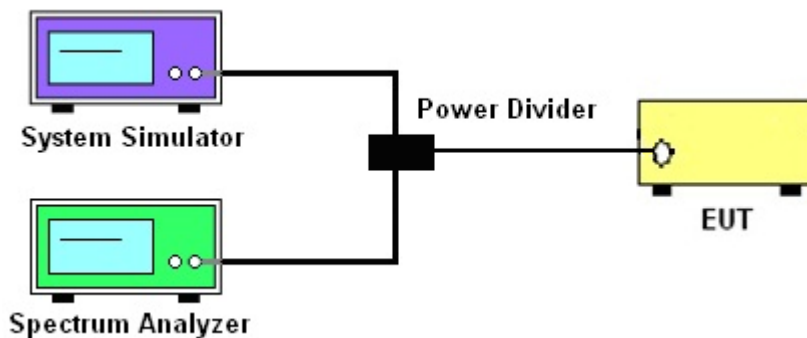

3.2.3 Frequency Stability

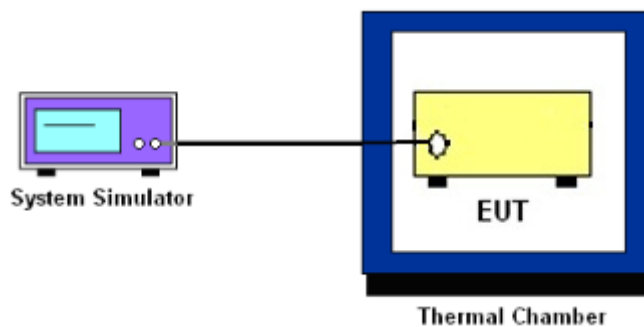

3.3 Test Result of Conducted Test

Please refer to Appendix A.



3.4 Conducted Output Power and ERP/EIRP

3.4.1 Description of the Conducted Output Power and ERP/EIRP

A system simulator was used to establish communication with the EUT. Its parameters were set to enforce EUT transmitting at the maximum power. The measured power in the radio frequency on the transmitter output terminals shall be reported.

The ERP of mobile transmitters must not exceed 7 Watts for GSM850 and WCDMA Band V.

The EIRP of mobile transmitters must not exceed 2 Watts for GSM1900 and WCDMA Band II.

The EIRP of mobile transmitters must not exceed 1 Watts for WCDMA Band IV.

According to KDB 412172 D01 Power Approach,

$EIRP = P_T + G_T - L_C$, $ERP = EIRP - 2.15$, where

P_T = transmitter output power in dBm

G_T = gain of the transmitting antenna in dBi

L_C = signal attenuation in the connecting cable between the transmitter and antenna in dB

3.4.2 Test Procedures

1. The testing follows ANSI C63.26 Section 5.2
2. The transmitter output port was connected to the system simulator.
3. Set EUT at maximum power through the system simulator.
4. Select lowest, middle, and highest channels for each band and different modulation.
5. Measure and record the power level from the system simulator.



3.5 Peak-to-Average Ratio

3.5.1 Description of the PAR Measurement

The peak-to-average ratio (PAR) of the transmission may not exceed 13 dB.

3.5.2 Test Procedures

1. The testing follows ANSI C63.26 Section 5.2.3.4 (CCDF).
2. The EUT was connected to spectrum and system simulator via a power divider.
3. Set the CCDF (Complementary Cumulative Distribution Function) option in spectrum analyzer.
4. The highest RF powers were measured and recorded the maximum PAPR level associated with a probability of 0.1 %.
5. Record the deviation as Peak to Average Ratio.

3.6 99% Occupied Bandwidth and 26dB Bandwidth Measurement

3.6.1 Description of 99% Occupied Bandwidth and 26dB Bandwidth Measurement

The occupied bandwidth is the width of a frequency band such that, below the lower and above the upper frequency limits, the mean powers emitted are each equal to a specified percentage 0.5% of the total mean transmitted power.

The 26 dB emission bandwidth is defined as the frequency range between two points, one above and one below the carrier frequency, at which the spectral density of the emission is attenuated 26 dB below the maximum in-band spectral density of the modulated signal. Spectral density (power per unit bandwidth) is to be measured with a detector of resolution bandwidth equal to approximately 1.0% of the emission bandwidth.

3.6.2 Test Procedures

1. The testing follows ANSI C63.26 Section 5.4
2. The EUT was connected to spectrum analyzer and system simulator via a power divider.
3. The spectrum analyzer center frequency is set to the nominal EUT channel center frequency. The span range for the spectrum analyzer shall be between two and five times the anticipated OBW.
4. The nominal resolution bandwidth (RBW) shall be in the range of 1 to 5 % of the anticipated OBW, and the VBW shall be at least 3 times the RBW.
5. Set the detection mode to peak, and the trace mode to max hold.
6. Determine the reference value: Set the EUT to transmit a modulated signal. Allow the trace to stabilize. Set the spectrum analyzer marker to the highest level of the displayed trace.
(this is the reference value)
7. Determine the “-26 dB down amplitude” as equal to (Reference Value – X).
8. Place two markers, one at the lowest and the other at the highest frequency of the envelope of the spectral display such that each marker is at or slightly below the “-X dB down amplitude” determined in step 6. If a marker is below this “-X dB down amplitude” value it shall be placed as close as possible to this value. The OBW is the positive frequency difference between the two markers.
9. Use the 99 % power bandwidth function of the spectrum analyzer and report the measured bandwidth.



3.7 Conducted Band Edge

3.7.1 Description of Conducted Band Edge Measurement

The power of any emission outside of the authorized operating frequency ranges must be lower than the transmitter power (P) by a factor of at least $43 + 10 \log (P)$ dB.

3.7.2 Test Procedures

1. The testing follows ANSI C63.26 section 5.7
2. The EUT was connected to the spectrum analyzer and system simulator via a power divider.
3. The RF output of EUT was connected to the spectrum analyzer by an RF cable and attenuator. The path loss was compensated to the results for each measurement.
4. The band edges of low and high channels for the highest RF powers were measured.
5. The RF fundamental frequency should be excluded against the limit line in the operating frequency band.
6. The limit line is derived from $43 + 10\log(P)$ dB below the transmitter power P(Watts)



3.8 Conducted Spurious Emission

3.8.1 Description of Conducted Spurious Emission Measurement

The power of any emission outside of the authorized operating frequency ranges must be lower than the transmitter power (P) by a factor of at least $43 + 10 \log (P)$ dB.

It is measured by means of a calibrated spectrum analyzer and scanned from 30 MHz up to a frequency including its 10th harmonic.

3.8.2 Test Procedures

1. The testing follows ANSI C63.26 section 5.7
2. The EUT was connected to the spectrum analyzer and system simulator via a power divider.
3. The RF output of EUT was connected to the spectrum analyzer by an RF cable and attenuator. The path loss was compensated to the results for each measurement.
4. The middle channel for the highest RF power within the transmitting frequency was measured.
5. The conducted spurious emission for the whole frequency range was taken.
6. The RF fundamental frequency should be excluded against the limit line in the operating frequency band.
7. The limit line is derived from $43 + 10\log(P)$ dB below the transmitter power P(Watts)



3.9 Frequency Stability

3.9.1 Description of Frequency Stability Measurement

The frequency stability shall be measured by variation of ambient temperature and variation of primary supply voltage to ensure that the fundamental emission stays within the authorized frequency block. The frequency stability of the transmitter shall be maintained within $\pm 0.00025\%$ ($\pm 2.5\text{ppm}$) of the center frequency.

3.9.2 Test Procedures for Temperature Variation

1. The testing follows ANSI C63.26 section 5.6.4
2. The EUT was set up in the thermal chamber and connected with the system simulator.
3. With power OFF, the temperature was decreased to -30°C and the EUT was stabilized before testing. Power was applied and the maximum change in frequency was recorded within one minute.
4. With power OFF, the temperature was raised in 10°C step up to 50°C . The EUT was stabilized at each step for at least half an hour. Power was applied and the maximum frequency change was recorded within one minute.

3.9.3 Test Procedures for Voltage Variation

1. The testing follows ANSI C63.26 section 5.6.5
2. The EUT was placed in a temperature chamber at $20\pm 5^{\circ}\text{C}$ and connected with the system simulator.
3. The power supply voltage to the EUT was varied from 85% to 115% of the nominal value for other than hand carried battery equipment.
4. For hand carried, battery powered equipment, reduce the primary ac or dc supply voltage to the battery operating end point, which shall be specified by the manufacturer.
5. The variation in frequency was measured for the worst case.

4 Radiated Test Items

4.1 Measuring Instruments

See list of measuring instruments of this test report.

4.2 Test Setup

4.2.1 For radiated test below 30MHz

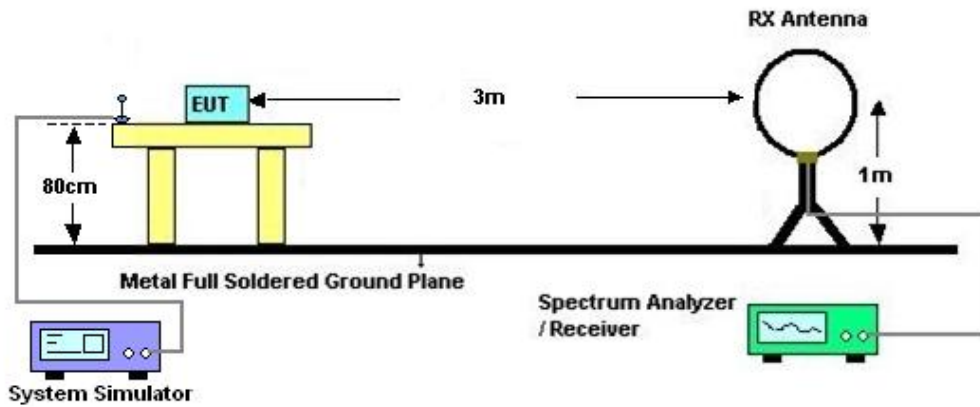

4.2.2 For radiated test from 30MHz to 1GHz

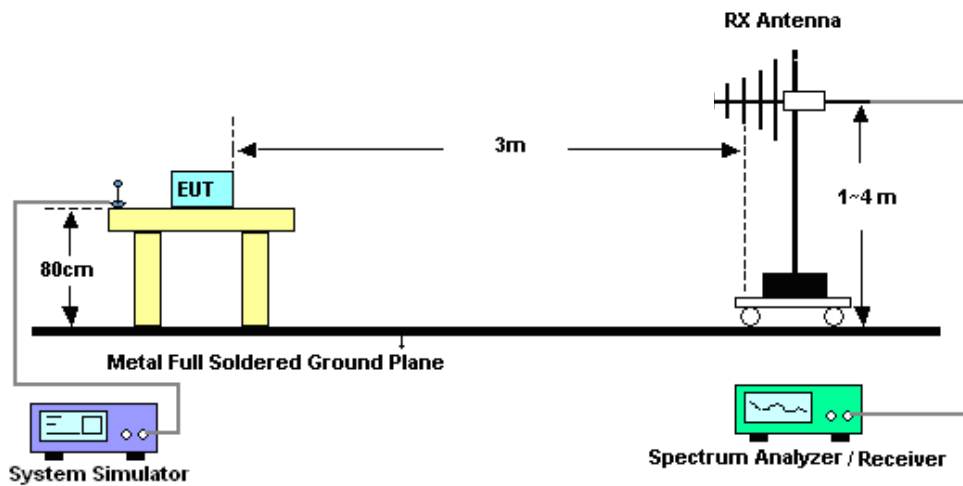

4.2.3 For radiated test above 1GHz

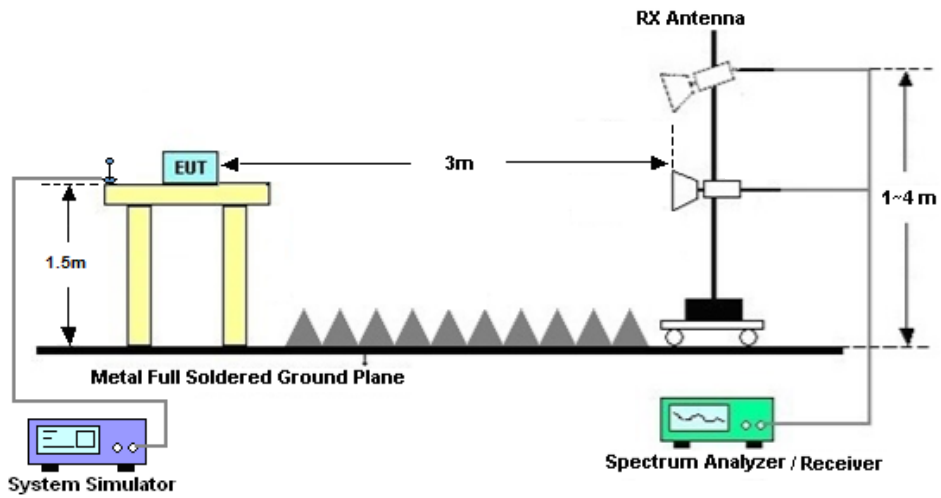

4.3 Test Result of Radiated Test

The low frequency, which started from 9 kHz to 30MHz, was pre-scanned and the result which was 20dB lower than the limit line was not reported.

Please refer to Appendix B.



4.4 Field Strength of Spurious Radiation Measurement

4.4.1 Description of Field Strength of Spurious Radiated Measurement

The power of any emission outside of the authorized operating frequency ranges must be attenuated below the transmitter power (P) by a factor of at least $43 + 10 \log (P)$ dB. The spectrum is scanned from 30 MHz up to a frequency including its 10th harmonic.

4.4.2 Test Procedures

1. The testing follows ANSI C63.26 Section 5.5
2. The EUT was placed on a rotatable wooden table 0.8 meters for frequency below 1GHz and 1.5 meter for frequency above 1GHz above the ground.
3. The EUT was set 3 meters from the receiving antenna, which was mounted on the antenna tower.
4. The table was rotated 360 degrees to determine the position of the highest spurious emission.
5. The height of the receiving antenna is varied between one meter and four meters to search for the maximum spurious emission for both horizontal and vertical polarizations.
6. Make the measurement with the spectrum analyzer's RBW = 1MHz, VBW = 3MHz, taking record of maximum spurious emission.
7. A horn antenna was substituted in place of the EUT and was driven by a signal generator.
8. Tune the output power of signal generator to the same emission level with EUT maximum spurious emission.
9. Taking the record of output power at antenna port.
10. Repeat step 7 to step 8 for another polarization.
11. $EIRP \text{ (dBm)} = S.G. \text{ Power} - Tx \text{ Cable Loss} + Tx \text{ Antenna Gain}$
12. $ERP \text{ (dBm)} = EIRP - 2.15$
13. The RF fundamental frequency should be excluded against the limit line in the operating frequency band.
14. The limit line is derived from $43 + 10\log(P)$ dB below the transmitter power P(Watts)



5 List of Measuring Equipment

Instrument	Manufacturer	Model No.	Serial No.	Characteristics	Calibration Date	Test Date	Due Date	Remark
EXA Spectrum Analyzer	Keysight	N9010A	MY55370528	10Hz-44G,MAX 30dB	Oct. 10, 2025	Mar. 15, 2026	Oct. 09, 2026	Radiation (03CH04-KS)
Active loop antenna	R&S	HFH2-Z2E	101125	9kHz~30MHz	Aug. 10, 2025	Mar. 15, 2026	Aug. 09, 2026	Radiation (03CH04-KS)
Bilog Antenna	TeseQ	CBL6111D	44483	30MHz-1GHz	Nov. 22, 2025	Mar. 15, 2026	Nov. 21, 2026	Radiation (03CH04-KS)
Double Ridge Horn Antenna	ETS-Lindgren	3117	00227860	1GHz~18GHz	Aug. 22, 2025	Mar. 15, 2026	Aug. 21, 2026	Radiation (03CH04-KS)
SHF-EHF Horn	Com-power	AH-840	101070	18GHz~40GHz	Jan. 10, 2026	Mar. 15, 2026	Jan. 09, 2027	Radiation (03CH04-KS)
Amplifier	SONOMA	310N	380826	9KHz-1GHz	Jul. 02, 2025	Mar. 15, 2026	Jul. 01, 2026	Radiation (03CH04-KS)
Amplifier	EM	EM18G40G A	060852	18~40GHz	Dec. 24, 2025	Mar. 15, 2026	Dec. 23, 2026	Radiation (03CH04-KS)
high gain Amplifier	EM	EM01G18G A	060890	1Ghz-18Ghz	May. 23, 2025	Mar. 15, 2026	May. 22, 2026	Radiation (03CH04-KS)
Amplifier	EM	EM01G18G A	060892	1Ghz-18Ghz	Oct. 11, 2025	Mar. 15, 2026	Oct. 10, 2026	Radiation (03CH04-KS)
AC Power Source	Chroma	61601	F104090004	N/A	NCR	Mar. 15, 2026	NCR	Radiation (03CH04-KS)
Turn Table	ChamPro	EM 1000-T	060762-T	0~360 degree	NCR	Mar. 15, 2026	NCR	Radiation (03CH04-KS)
Antenna Mast	ChamPro	EM 1000-A	060762-A	1 m~4 m	NCR	Mar. 15, 2026	NCR	Radiation (03CH04-KS)
Spectrum Analyzer	R&S	FSV40	101040	10Hz~40GHz	Jul. 07, 2025	Feb. 26, 2026	Jul. 06, 2026	Conducted (TH01-KS)
Power divider	STI	STI08-0055	-	0.5~40GHz	NCR	Feb. 26, 2026	NCR	Conducted (TH01-KS)
Radio communication	Anritsu	MT8821C	6261806798	2G/3G/LTE band 1-46 ,48,65-70	Jul. 03, 2025	Feb. 26, 2026	Jul. 02, 2026	Conducted (TH01-KS)
Temperature & humidity	Hongzhan	LP-150U	H2014011440	-40~+150°C 20%~95%RH	Jul. 02, 2025	Feb. 26, 2026	Jul. 01, 2026	Conducted (TH01-KS)

NCR: No Calibration Required



6 Measurement Uncertainty

The measurement uncertainties shown below were calculated in accordance with the requirements of ANSI 63.26-2015. All the measurement uncertainty value were shown with a coverage K=2 to indicate 95% level of confidence. The measurement data show herein meets or exceeds the CISPR measurement uncertainty values specified in CISPR 16-4-2 and can be compared directly to specified limit to determine compliance.

Uncertainty of Conducted Measurement

Conducted Spurious Emission & Bandedge	±2.00 dB
Occupied Channel Bandwidth	±0.384%
Conducted Power	±0.90 dB
Peak to Average Ratio	±0.90 dB
Frequency Stability	±0.38 ppm

Uncertainty of Radiated Emission Measurement (30 MHz ~ 1 GHz)

Measuring Uncertainty for a Level of Confidence of 95% (U = 2Uc(y))	2.83dB
---	--------

Uncertainty of Radiated Emission Measurement (1 GHz ~ 18 GHz)

Measuring Uncertainty for a Level of Confidence of 95% (U = 2Uc(y))	2.83dB
---	--------

Uncertainty of Radiated Emission Measurement (18 GHz ~ 40 GHz)

Measuring Uncertainty for a Level of Confidence of 95% (U = 2Uc(y))	2.82dB
---	--------

----- THE END -----



Appendix A. Test Results of Conducted Test

Test Engineer :	Simle Wang	Temperature :	22~23°C
		Relative Humidity :	40~42%

Conducted Output Power(Average power) and ERP/EIRP

GSM 850:

GSM850 TX Channel	Burst Average Power (dBm)			ERP(W)		
	128	189	251	L	M	H
Frequency (MHz)	824.2	836.4	848.8			
GSM 1 Tx slot	32.37	32.27	32.04	0.4188	0.4093	0.3882
GPRS 1 Tx slot	32.40	32.34	32.05	0.4217	0.4159	0.3890
GPRS 2 Tx slots	30.35	30.37	30.24	0.2630	0.2642	0.2564
GPRS 3 Tx slots	28.62	28.61	28.54	0.1766	0.1762	0.1734
GPRS 4 Tx slots	26.62	26.58	26.45	0.1114	0.1104	0.1072

GSM 1900:

GSM1900 TX Channel	Burst Average Power (dBm)			EIRP(W)		
	512	661	810	L	M	H
Frequency (MHz)	1850.2	1880	1909.8			
GSM 1 Tx slot	28.17	28.45	28.52	0.3289	0.3508	0.3565
GPRS 1 Tx slot	28.23	28.48	28.60	0.3334	0.3532	0.3631
GPRS 2 Tx slots	26.22	26.17	26.35	0.2099	0.2075	0.2163
GPRS 3 Tx slots	24.75	24.84	24.82	0.1496	0.1528	0.1521
GPRS 4 Tx slots	22.71	22.57	22.74	0.0935	0.0906	0.0942

WCDMA V:

Band TX Channel	WCDMA V			ERP(W)		
	4132	4182	4233	L	M	H
Rx Channel	4357	4407	4458			
Frequency (MHz)	826.4	836.4	846.6			
3GPP Rel 99 AMR 12.2Kbps	22.04	22.14	22.10	0.0388	0.0397	0.0394
3GPP Rel 99 RMC 12.2Kbps	22.08	22.15	22.12	0.0392	0.0398	0.0395
3GPP Rel 6 HSDPA Subtest-1	21.08	21.14	21.19	0.0311	0.0316	0.0319
3GPP Rel 6 HSDPA Subtest-2	21.10	21.14	21.08	0.0313	0.0316	0.0311
3GPP Rel 6 HSDPA Subtest-3	20.59	20.63	20.60	0.0278	0.0281	0.0279
3GPP Rel 6 HSDPA Subtest-4	20.57	20.64	20.58	0.0277	0.0281	0.0277
3GPP Rel 8 DC-HSDPA Subtest-1	21.10	21.17	21.13	0.0313	0.0318	0.0315
3GPP Rel 8 DC-HSDPA Subtest-2	21.01	21.02	21.02	0.0306	0.0307	0.0307
3GPP Rel 8 DC-HSDPA Subtest-3	20.51	20.60	20.54	0.0273	0.0279	0.0275
3GPP Rel 8 DC-HSDPA Subtest-4	20.51	20.50	20.56	0.0273	0.0272	0.0276
3GPP Rel 6 HSUPA Subtest-1	21.07	21.07	21.01	0.0310	0.0310	0.0306
3GPP Rel 6 HSUPA Subtest-2	19.04	19.15	19.07	0.0195	0.0200	0.0196
3GPP Rel 6 HSUPA Subtest-3	20.13	20.22	20.15	0.0250	0.0255	0.0251
3GPP Rel 6 HSUPA Subtest-4	19.01	19.04	19.04	0.0193	0.0195	0.0195
3GPP Rel 6 HSUPA Subtest-5	21.07	21.09	21.00	0.0310	0.0312	0.0305
3GPP Rel 7 HSPA+ (16QAM) Subtest-1	18.57	18.72	18.62	0.0175	0.0181	0.0177



WCDMA IV:

Band		WCDMA IV			EIRP(W)		
TX Channel		1312	1413	1513	EIRP(W)		
Rx Channel		1537	1638	1738	EIRP(W)		
Frequency (MHz)		1712.4	1732.6	1752.6	L	M	H
3GPP Rel 99	AMR 12.2Kbps	22.20	22.34	21.64	0.0661	0.0682	0.0581
3GPP Rel 99	RMC 12.2Kbps	22.21	22.37	21.74	0.0662	0.0687	0.0594
3GPP Rel 6	HSDPA Subtest-1	21.25	21.39	20.76	0.0531	0.0548	0.0474
3GPP Rel 6	HSDPA Subtest-2	21.26	21.29	20.69	0.0532	0.0536	0.0467
3GPP Rel 6	HSDPA Subtest-3	20.83	20.91	20.26	0.0482	0.0491	0.0423
3GPP Rel 6	HSDPA Subtest-4	20.72	20.79	20.19	0.0470	0.0478	0.0416
3GPP Rel 8	DC-HSDPA Subtest-1	21.26	21.32	20.71	0.0532	0.0540	0.0469
3GPP Rel 8	DC-HSDPA Subtest-2	21.15	21.27	20.60	0.0519	0.0533	0.0457
3GPP Rel 8	DC-HSDPA Subtest-3	20.69	20.80	20.10	0.0467	0.0479	0.0407
3GPP Rel 8	DC-HSDPA Subtest-4	20.59	20.70	20.10	0.0456	0.0468	0.0407
3GPP Rel 6	HSUPA Subtest-1	21.10	21.26	20.64	0.0513	0.0532	0.0461
3GPP Rel 6	HSUPA Subtest-2	19.26	19.31	18.73	0.0336	0.0340	0.0297
3GPP Rel 6	HSUPA Subtest-3	20.36	20.44	19.83	0.0433	0.0441	0.0383
3GPP Rel 6	HSUPA Subtest-4	19.23	19.26	18.64	0.0333	0.0336	0.0291
3GPP Rel 6	HSUPA Subtest-5	21.23	21.29	20.63	0.0528	0.0536	0.0460
3GPP Rel 7	HSPA+ (16QAM) Subtest-1	18.81	18.95	18.31	0.0303	0.0313	0.0270

WCDMA II:

Band		WCDMA II			EIRP(W)		
TX Channel		9262	9400	9538	EIRP(W)		
Rx Channel		9662	9800	9938	EIRP(W)		
Frequency (MHz)		1852.4	1880	1907.6	L	M	H
3GPP Rel 99	AMR 12.2Kbps	22.07	22.20	22.13	0.0807	0.0832	0.0818
3GPP Rel 99	RMC 12.2Kbps	22.12	22.22	22.21	0.0817	0.0836	0.0834
3GPP Rel 6	HSDPA Subtest-1	21.21	21.31	21.25	0.0662	0.0678	0.0668
3GPP Rel 6	HSDPA Subtest-2	21.12	21.25	21.14	0.0649	0.0668	0.0652
3GPP Rel 6	HSDPA Subtest-3	20.73	20.77	20.67	0.0593	0.0598	0.0585
3GPP Rel 6	HSDPA Subtest-4	20.62	20.73	20.63	0.0578	0.0593	0.0579
3GPP Rel 8	DC-HSDPA Subtest-1	21.13	21.27	21.21	0.0650	0.0671	0.0662
3GPP Rel 8	DC-HSDPA Subtest-2	21.07	21.13	21.15	0.0641	0.0650	0.0653
3GPP Rel 8	DC-HSDPA Subtest-3	20.53	20.70	20.59	0.0566	0.0589	0.0574
3GPP Rel 8	DC-HSDPA Subtest-4	20.52	20.66	20.58	0.0565	0.0583	0.0573
3GPP Rel 6	HSUPA Subtest-1	21.03	21.19	21.09	0.0635	0.0659	0.0644
3GPP Rel 6	HSUPA Subtest-2	19.21	19.30	19.15	0.0418	0.0427	0.0412
3GPP Rel 6	HSUPA Subtest-3	20.21	20.34	20.30	0.0526	0.0542	0.0537
3GPP Rel 6	HSUPA Subtest-4	19.17	19.20	19.16	0.0414	0.0417	0.0413
3GPP Rel 6	HSUPA Subtest-5	21.05	21.26	21.08	0.0638	0.0670	0.0643
3GPP Rel 7	HSPA+ (16QAM) Subtest-1	18.76	18.80	18.77	0.0377	0.0380	0.0378



A1. GSM

Peak-to-Average Ratio

Mode	GSM850		Limit: 13dB
Mod.	GSM		Result
Lowest CH	0.12		PASS
Middle CH	0.12		
Highest CH	0.12		

Mode	GSM1900		Limit: 13dB
Mod.	GSM		Result
Lowest CH	0.20		PASS
Middle CH	0.12		
Highest CH	0.20		



GSM850 (GSM)

Lowest Channel

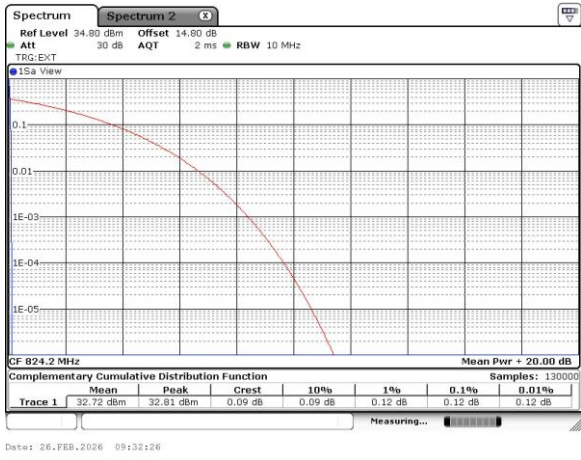

Middle Channel

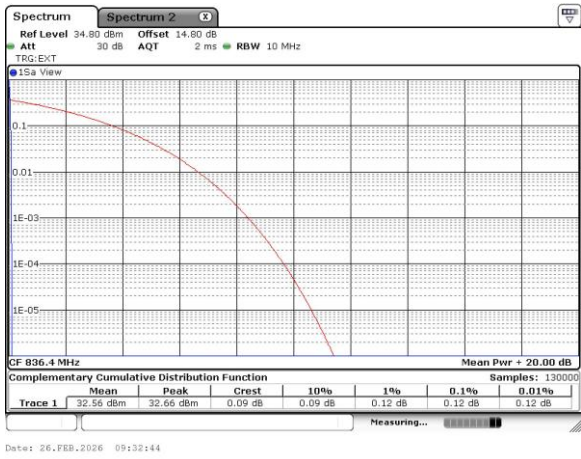

Highest Channel

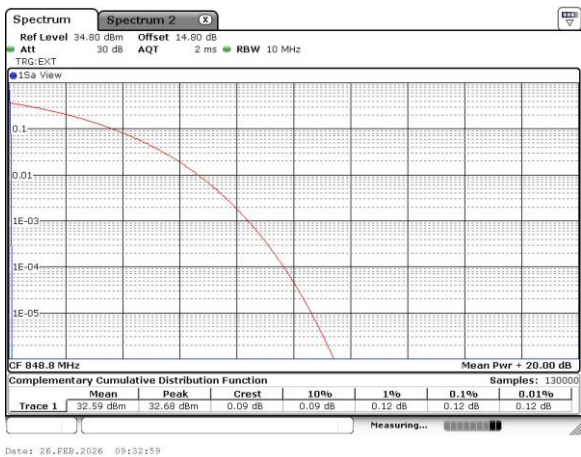



GSM1900 (GSM)

Lowest Channel

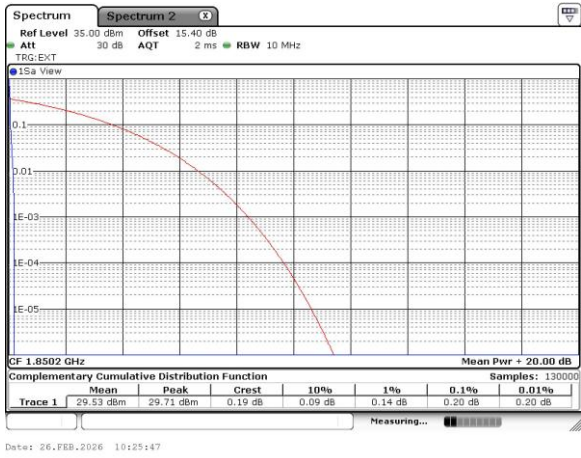

Date: 26.FEB.2026 10:25:47

Middle Channel

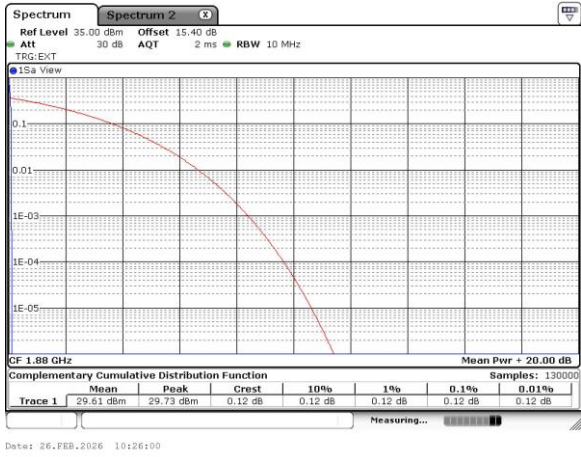

Date: 26.FEB.2026 10:26:00

Highest Channel

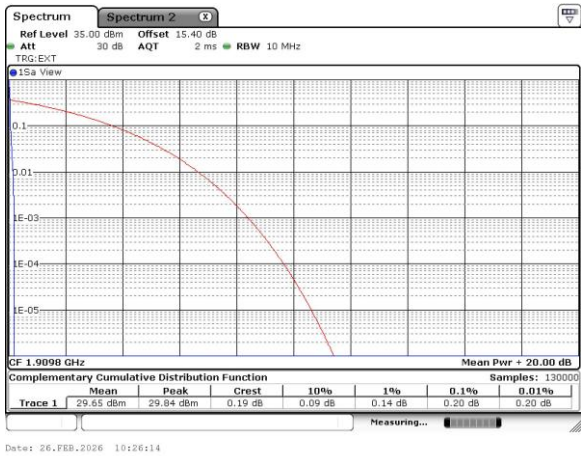

Date: 26.FEB.2026 10:26:14



26dB Bandwidth

Mode	GSM850	
Mod.	GSM	
Lowest CH	0.302	
Middle CH	0.302	
Highest CH	0.310	

Mode	GSM1900	
Mod.	GSM	
Lowest CH	0.310	
Middle CH	0.302	
Highest CH	0.311	



GSM850 (GSM)

Lowest Channel

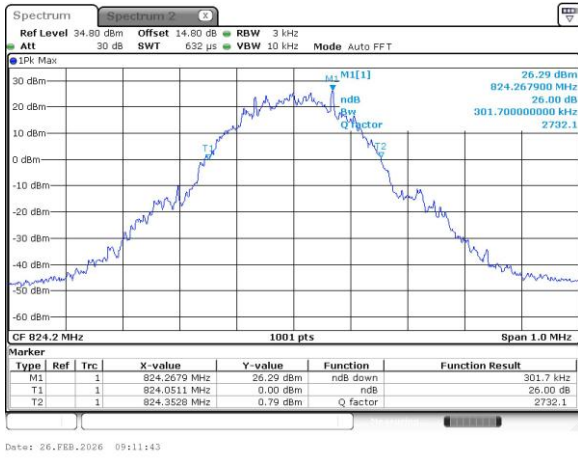

Middle Channel

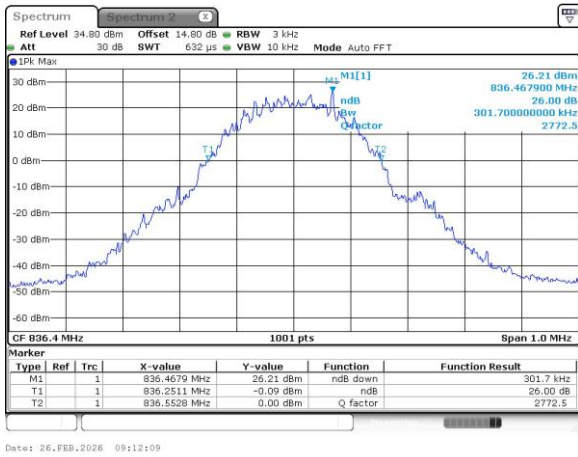

Highest Channel

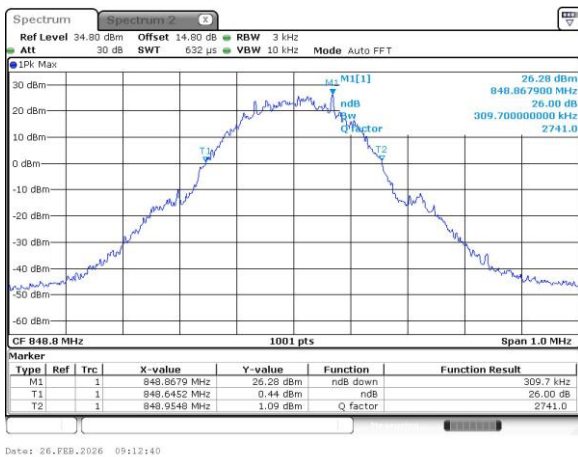



GSM1900 (GSM)

Lowest Channel

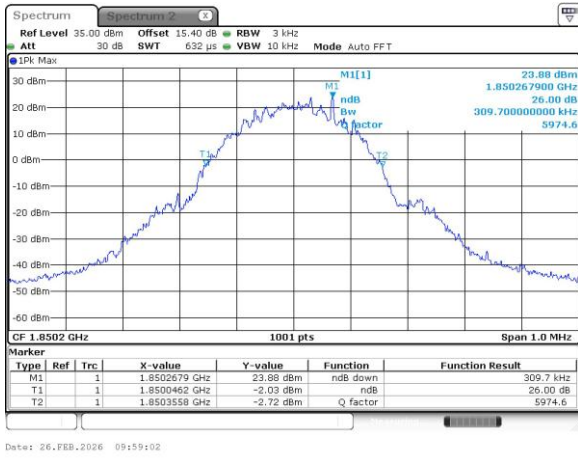

Middle Channel

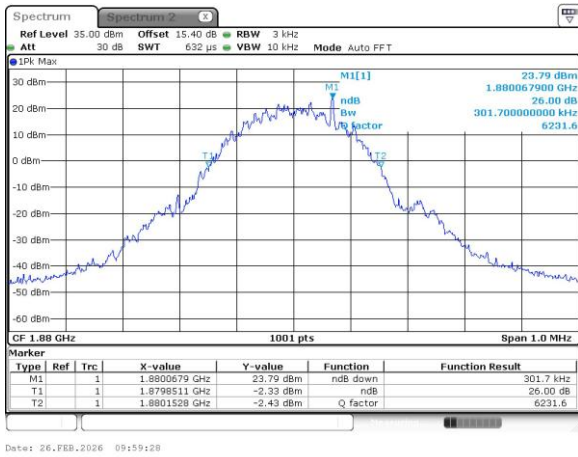

Highest Channel

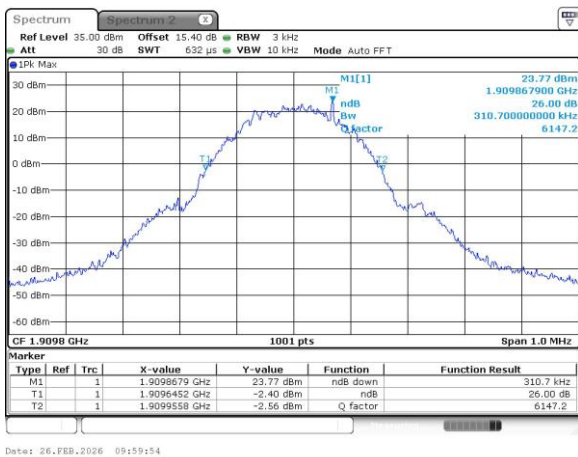



Occupied Bandwidth

Mode	GSM850	
Mod.	GSM	
Lowest CH	0.239	
Middle CH	0.241	
Highest CH	0.239	

Mode	GSM1900	
Mod.	GSM	
Lowest CH	0.240	
Middle CH	0.240	
Highest CH	0.238	



GSM850 (GSM)

Lowest Channel

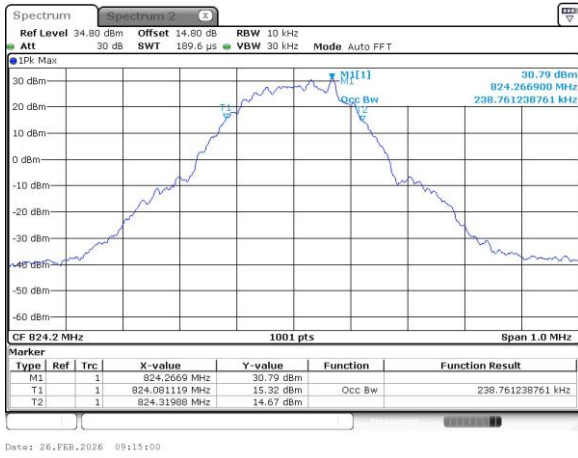

Date: 26.FEB.2026 09:15:00

Middle Channel

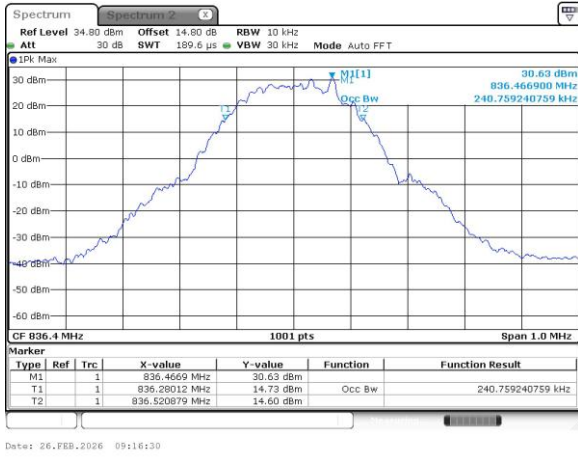

Date: 26.FEB.2026 09:16:30

Highest Channel



Date: 26.FEB.2026 09:17:05



GSM1900 (GSM)

Lowest Channel

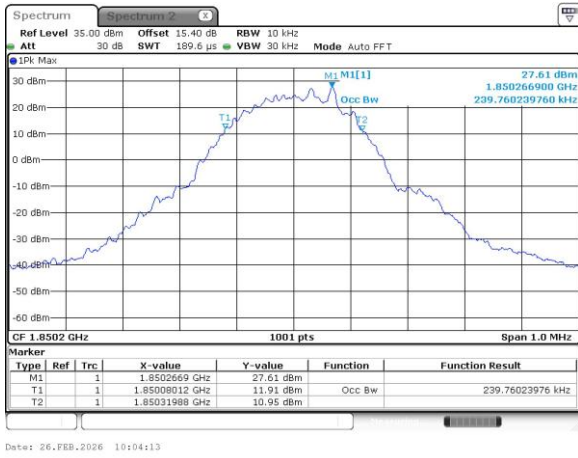

Date: 26.FEB.2026 10:04:13

Middle Channel

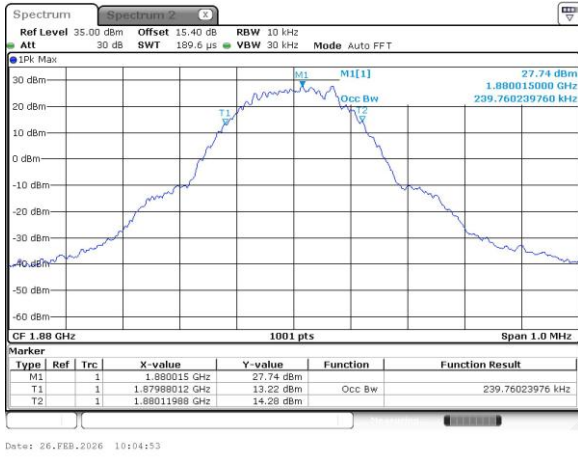

Date: 26.FEB.2026 10:04:53

Highest Channel



Date: 26.FEB.2026 10:06:39



Conducted Band Edge

GSM850 (GSM)

Lowest Band Edge

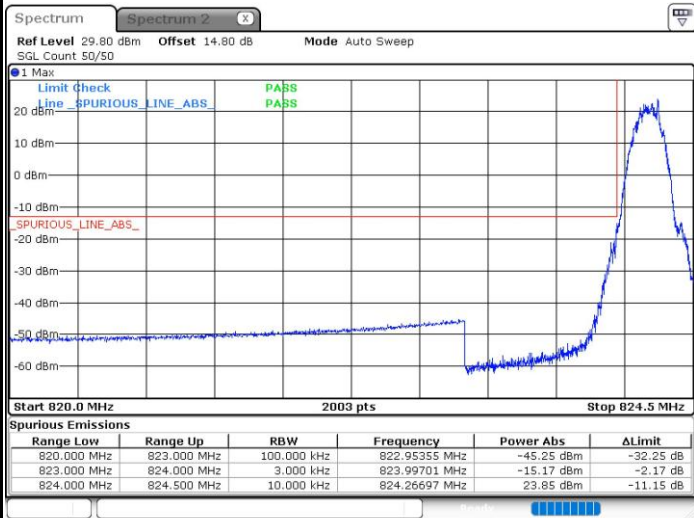

Highest Band Edge

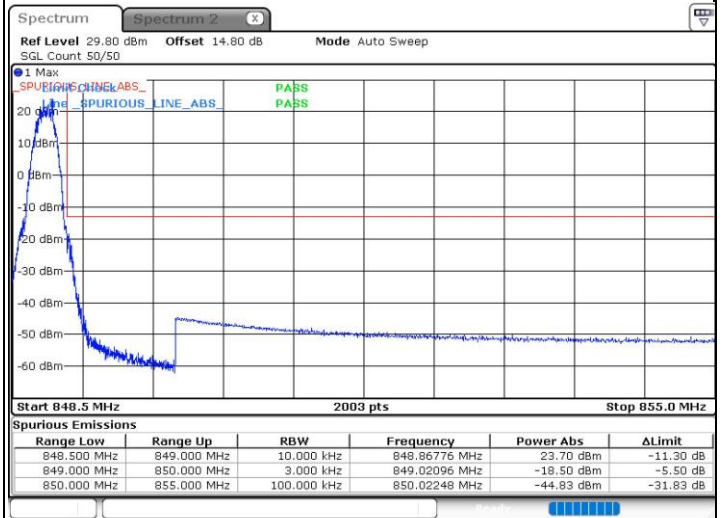

GSM1900 (GSM)

Lowest Band Edge

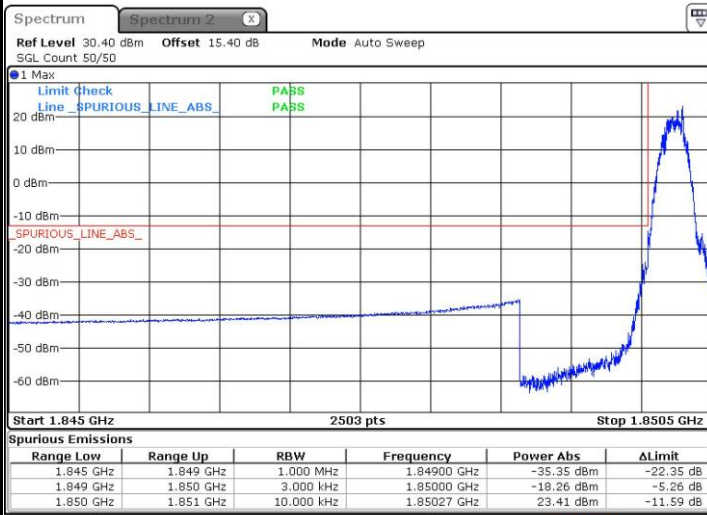

Highest Band Edge

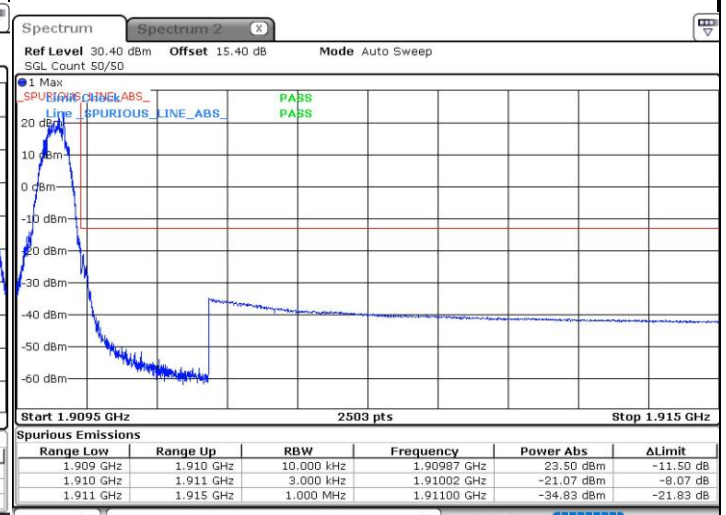



Conducted Spurious Emission

GSM850 (GSM)

Lowest Channel

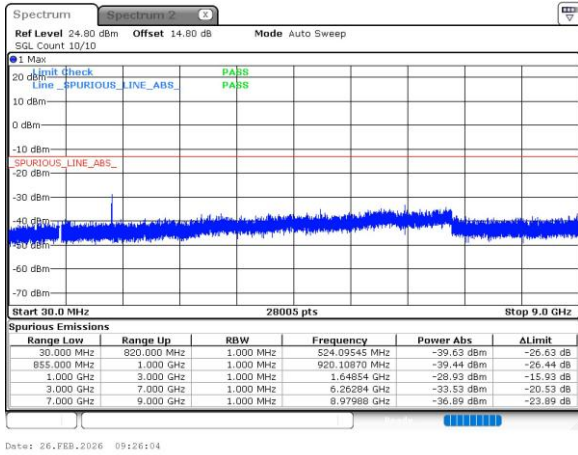

Middle Channel

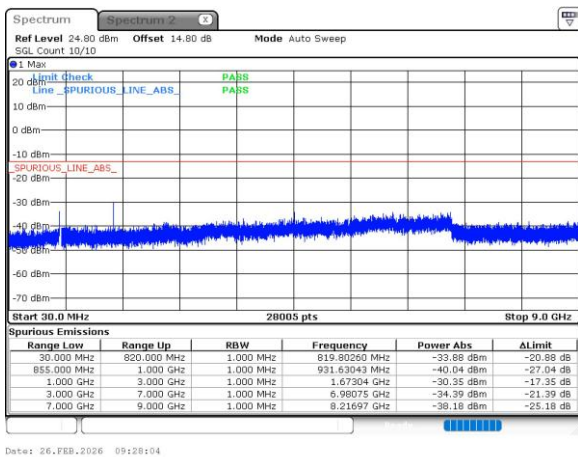

Highest Channel

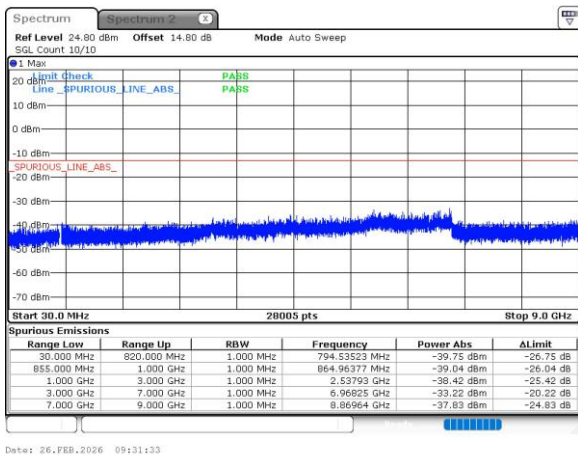



GSM1900 (GSM)

Lowest Channel

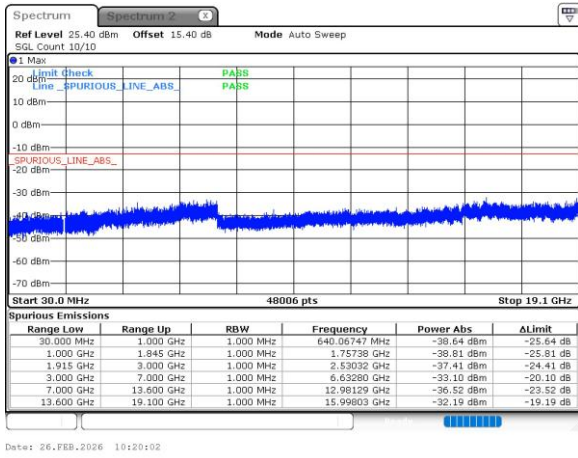

Date: 26.FEB.2026 10:20:02

Middle Channel

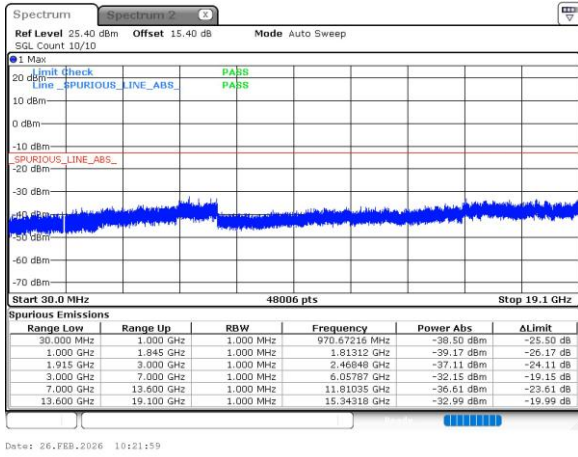

Date: 26.FEB.2026 10:21:59

Highest Channel

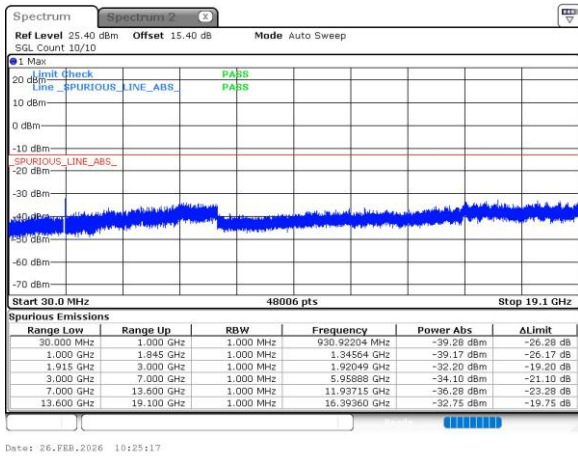

Date: 26.FEB.2026 10:25:17



Frequency Stability

Test Conditions Temperature (°C)	Middle Channel Voltage (Volt)	GSM850(GSM)		Limit 2.5ppm
		Deviation (ppm)		Result
50	Normal Voltage	0.0049		PASS
40	Normal Voltage	0.0526		
30	Normal Voltage	0.0078		
20(Ref.)	Normal Voltage	0.0000		
10	Normal Voltage	0.0463		
0	Normal Voltage	0.0512		
-10	Normal Voltage	0.0648		
-20	Normal Voltage	0.0735		
-30	Normal Voltage	0.0622		
20	Maximum Voltage	0.0441		
20	Normal Voltage	0.0091		
20	Battery End Point	0.0024		

Test Conditions Temperature (°C)	Middle Channel Voltage (Volt)	GSM1900(GSM)		Limit Note 2.
		Deviation (ppm)		Result
50	Normal Voltage	0.0049		PASS
40	Normal Voltage	0.0027		
30	Normal Voltage	0.0062		
20(Ref.)	Normal Voltage	0.0000		
10	Normal Voltage	0.0150		
0	Normal Voltage	0.0014		
-10	Normal Voltage	0.0173		
-20	Normal Voltage	0.0056		
-30	Normal Voltage	0.0071		
20	Maximum Voltage	0.0062		
20	Normal Voltage	0.0049		
20	Battery End Point	0.0066		

Note:

1. Normal Voltage = 3.87V ; Battery End Point (BEP) =3.5V. ; Maximum Voltage =4.45V
2. The frequency fundamental emissions stay within the authorized frequency block based on the frequency deviation measured is small.



A2. WCDMA

Peak-to-Average Ratio

Mode	WCDMA Band V	WCDMA Band II	WCDMA Band IV	Limit: 13dB
Mod.	RMC 12.2Kbps	RMC 12.2Kbps	RMC 12.2Kbps	Result
Lowest CH	3.19	2.99	2.99	PASS
Middle CH	3.30	2.99	3.04	
Highest CH	3.30	2.93	2.99	



WCDMA Band V (RMC 12.2Kbps)

WCDMA Band II (RMC 12.2Kbps)

Lowest Channel

Lowest Channel

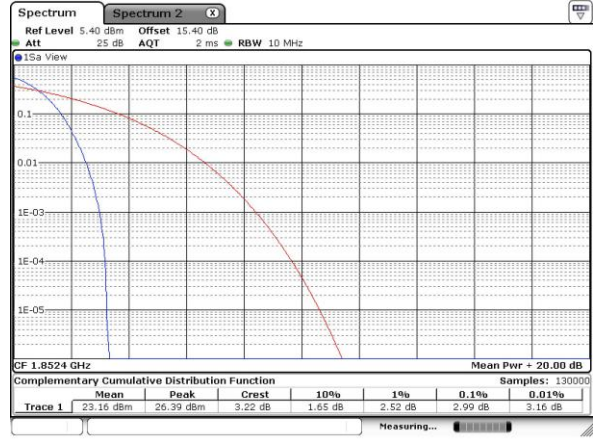

Date: 26.FEB.2026 13:48:31

Date: 26.FEB.2026 12:13:48

Middle Channel

Middle Channel

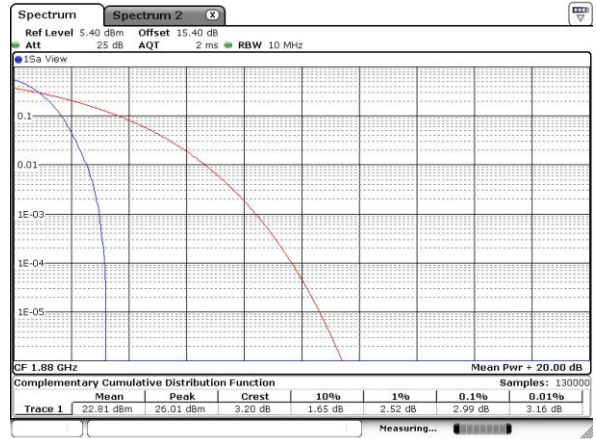
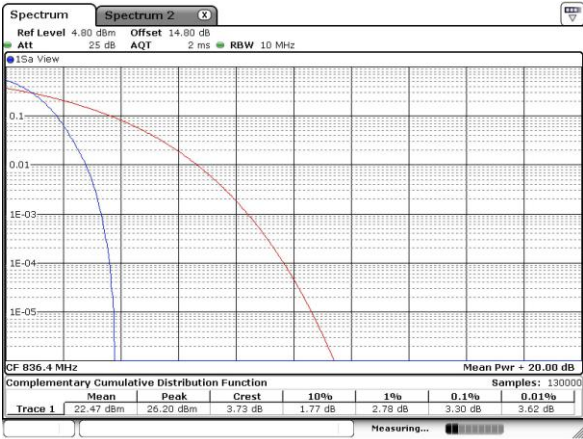

Date: 26.FEB.2026 13:48:16

Date: 26.FEB.2026 12:13:05

Highest Channel

Highest Channel

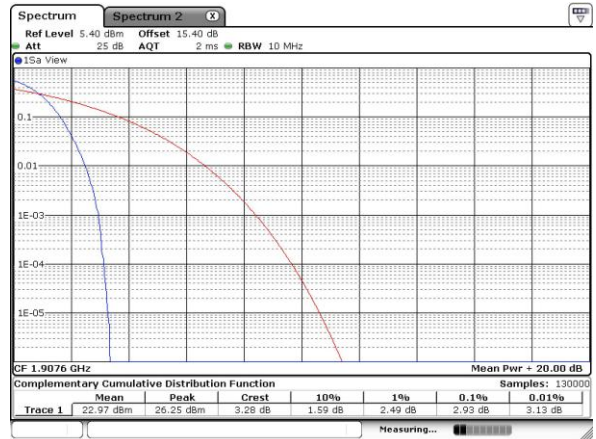
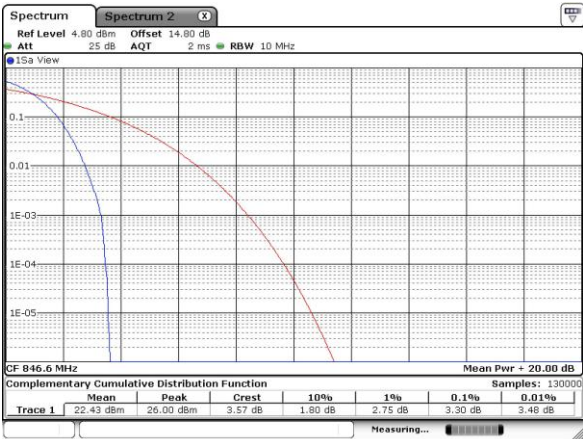

Date: 26.FEB.2026 13:49:01

Date: 26.FEB.2026 12:13:29



WCDMA Band IV (RMC 12.2Kbps)

Lowest Channel

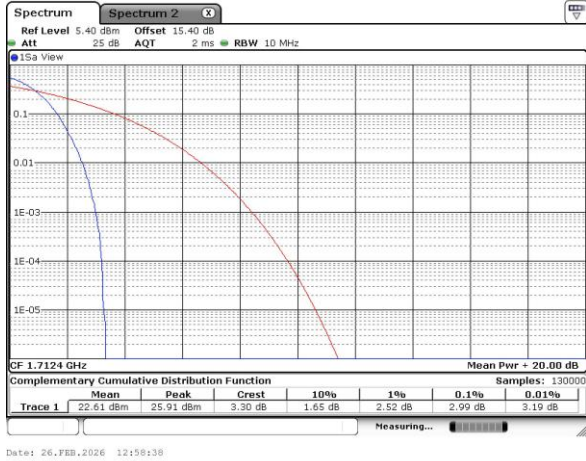

Middle Channel

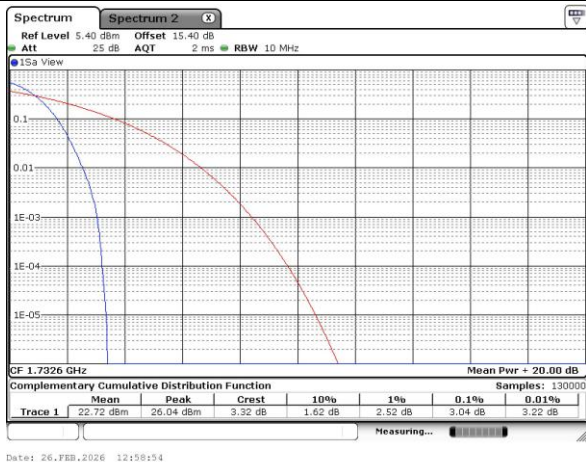

Highest Channel





26dB Bandwidth

Mode	WCDMA Band V	WCDMA Band II	WCDMA Band IV
Mod.	RMC 12.2Kbps	RMC 12.2Kbps	RMC 12.2Kbps
Lowest CH	4.655	4.675	4.675
Middle CH	4.665	4.675	4.665
Highest CH	4.655	4.675	4.675



WCDMA Band V (RMC 12.2Kbps)

WCDMA Band II (RMC 12.2Kbps)

Lowest Channel

Lowest Channel

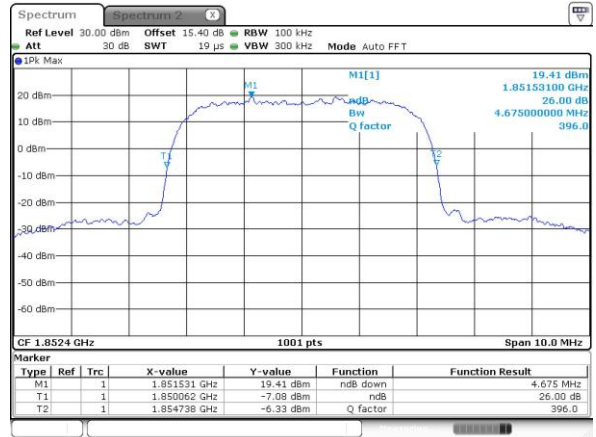
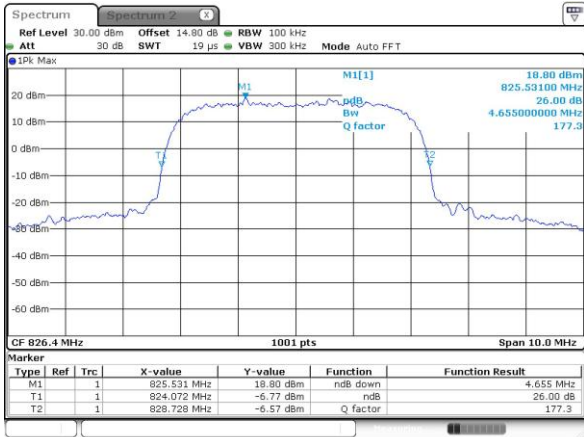

Date: 26.FEB.2026 13:27:35

Date: 26.FEB.2026 10:59:33

Middle Channel

Middle Channel

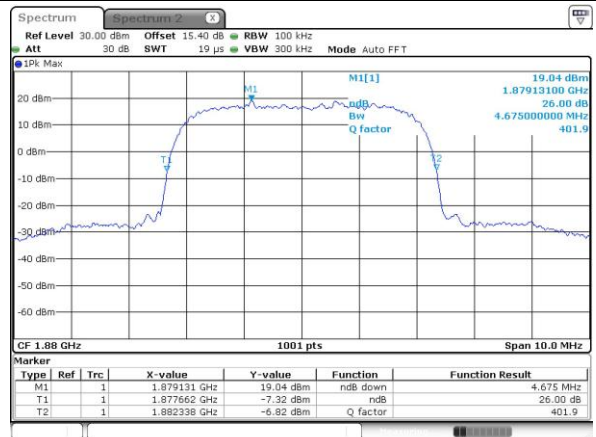
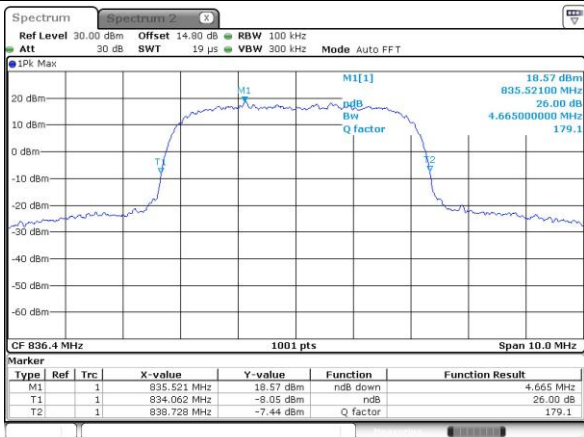

Date: 26.FEB.2026 13:28:08

Date: 26.FEB.2026 11:00:13

Highest Channel

Highest Channel

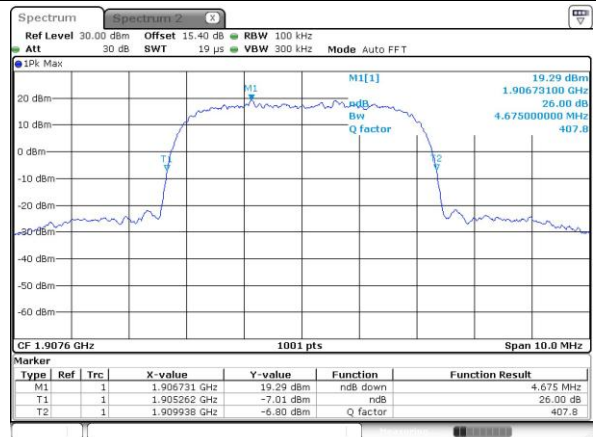
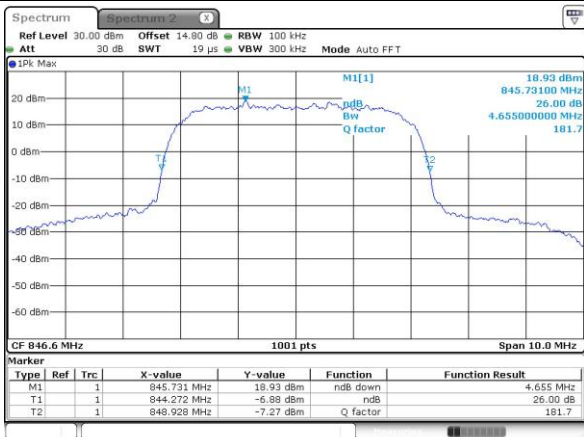

Date: 26.FEB.2026 13:28:39

Date: 26.FEB.2026 11:00:46



WCDMA Band IV (RMC 12.2Kbps)

Lowest Channel

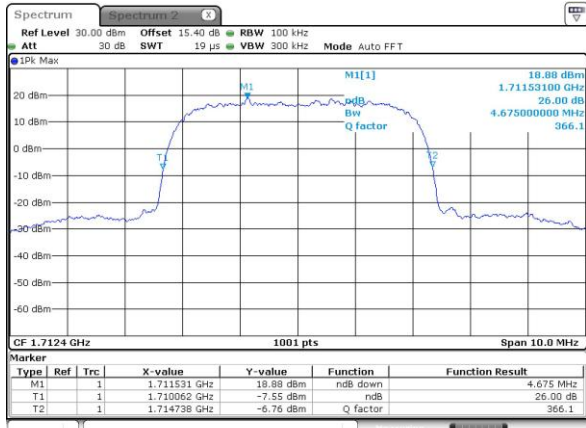

Date: 26.FEB.2026 12:40:25

Middle Channel

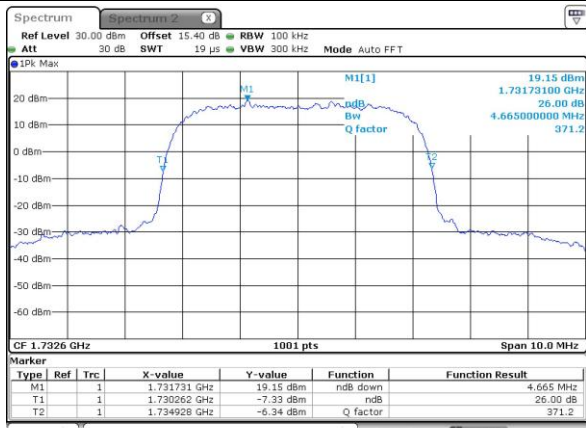

Date: 26.FEB.2026 12:41:30

Highest Channel

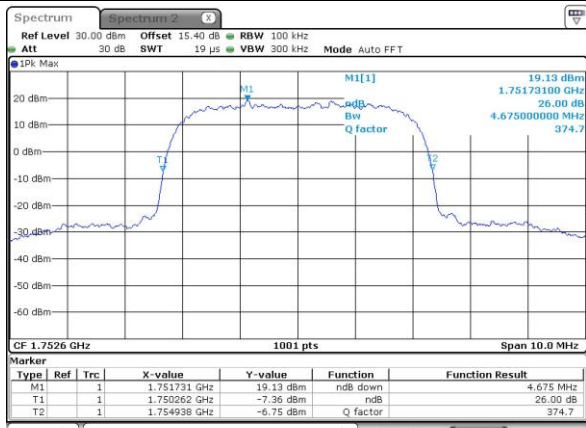

Date: 26.FEB.2026 12:42:02



Occupied Bandwidth

Mode	WCDMA Band V(MHz)	WCDMA Band II(MHz)	WCDMA Band IV(MHz)
Mod.	RMC 12.2Kbps	RMC 12.2Kbps	RMC 12.2Kbps
Lowest CH	4.146	4.126	4.146
Middle CH	4.136	4.146	4.126
Highest CH	4.136	4.136	4.146



WCDMA Band V (RMC 12.2Kbps)

Lowest Channel

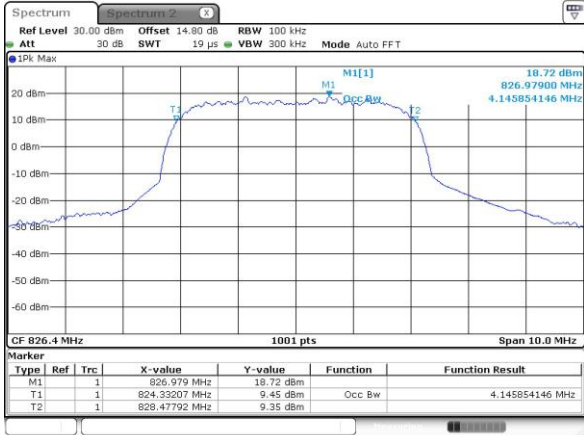

WCDMA Band II (RMC 12.2Kbps)

Lowest Channel

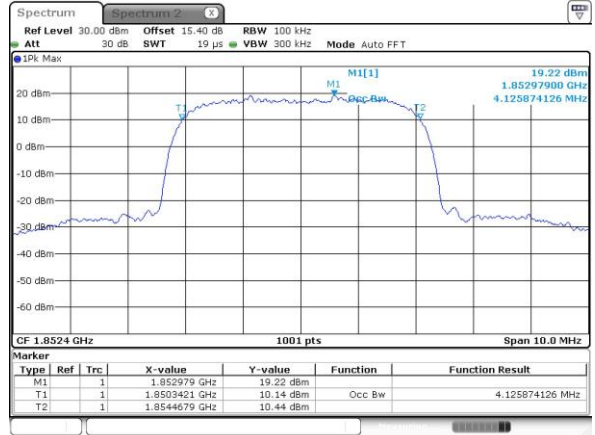

Middle Channel

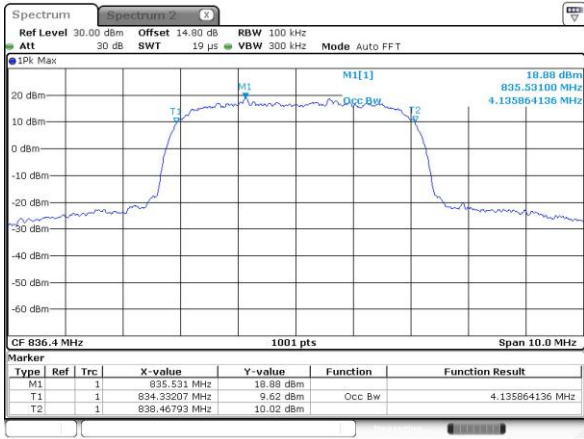

Middle Channel

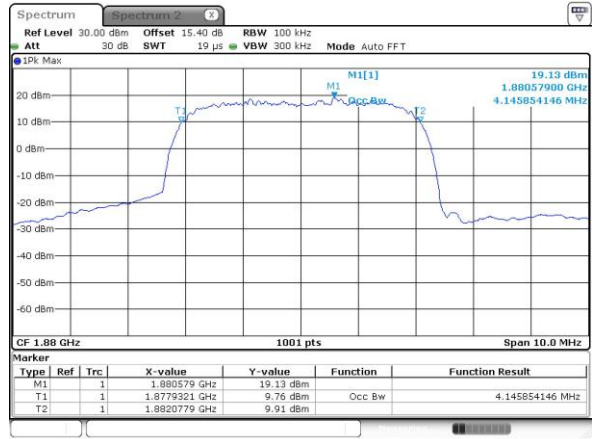

Highest Channel

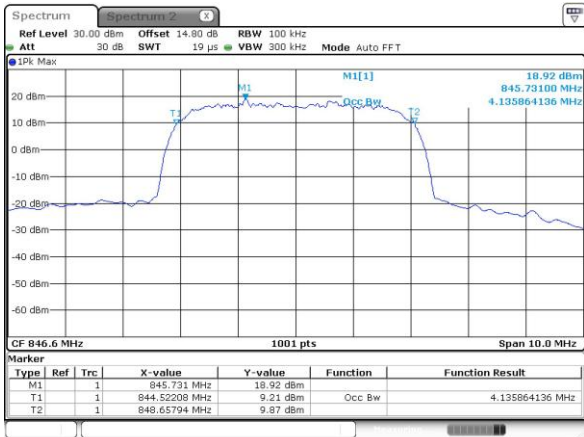

Highest Channel

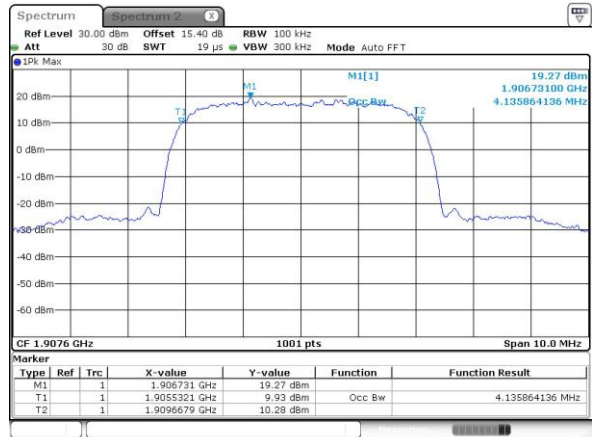



WCDMA Band IV (RMC 12.2Kbps)

Lowest Channel

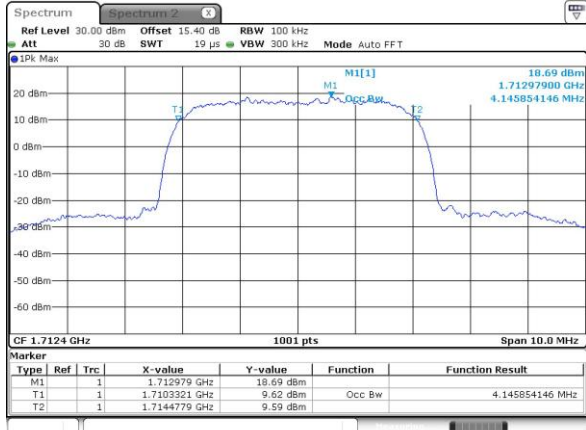

Date: 26.FEB.2026 12:42:50

Middle Channel

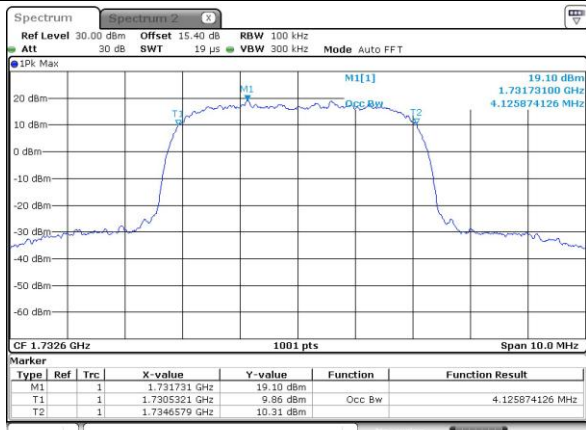

Date: 26.FEB.2026 12:43:19

Highest Channel

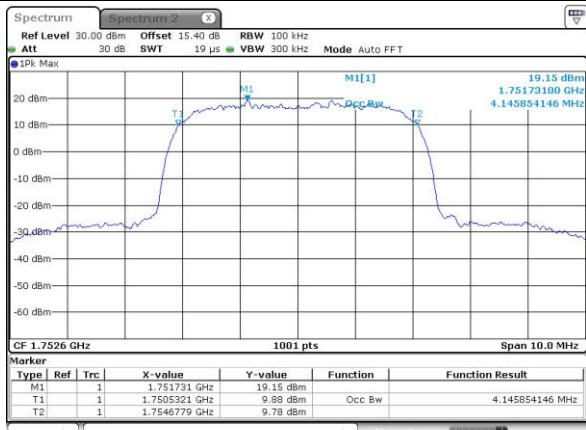

Date: 26.FEB.2026 12:43:53



Conducted Band Edge

WCDMA Band V (RMC 12.2Kbps)

Lowest Band Edge

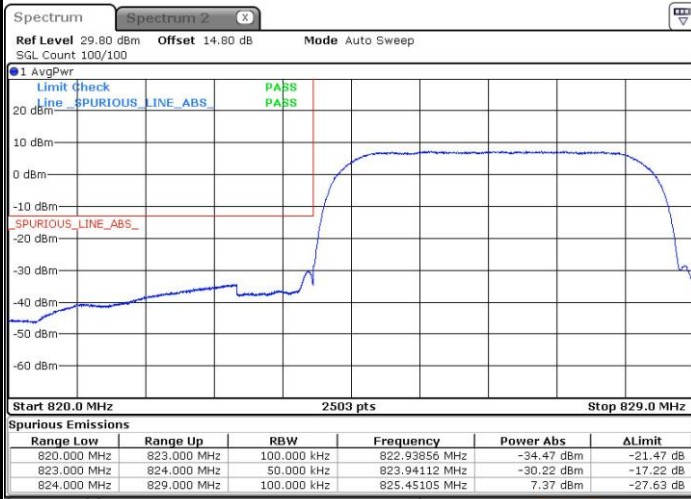

Highest Band Edge



WCDMA Band II (RMC 12.2Kbps)

Lowest Band Edge

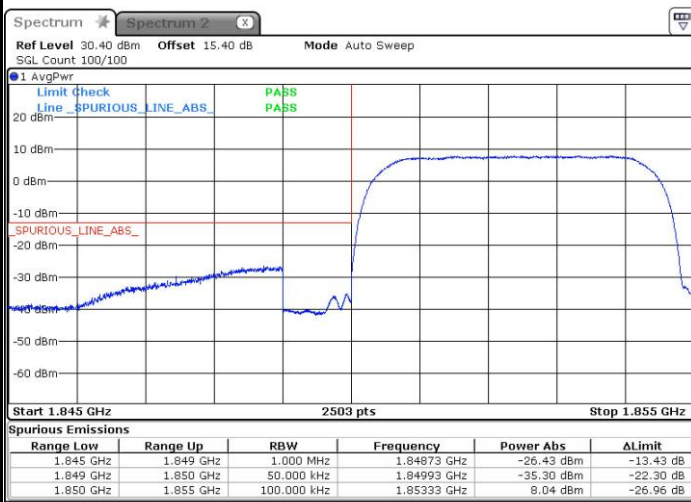

Highest Band Edge





WCDMA Band IV (RMC 12.2Kbps)

Lowest Band Edge

Highest Band Edge

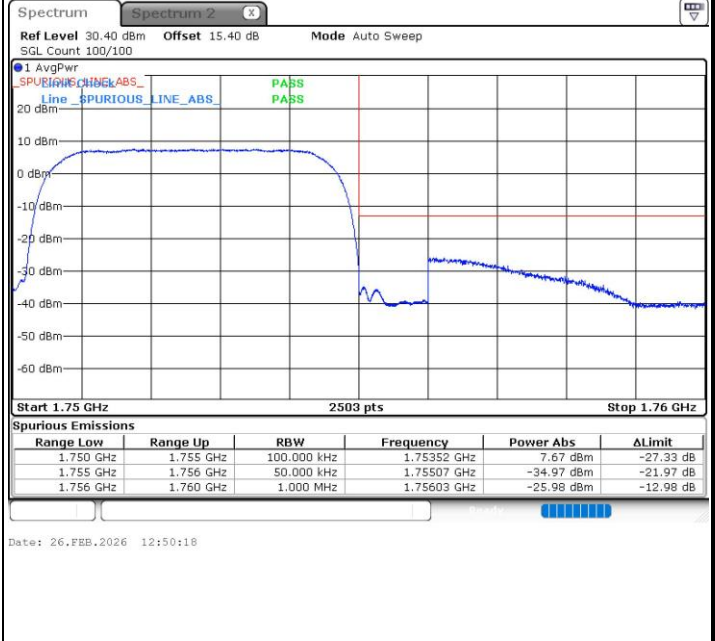
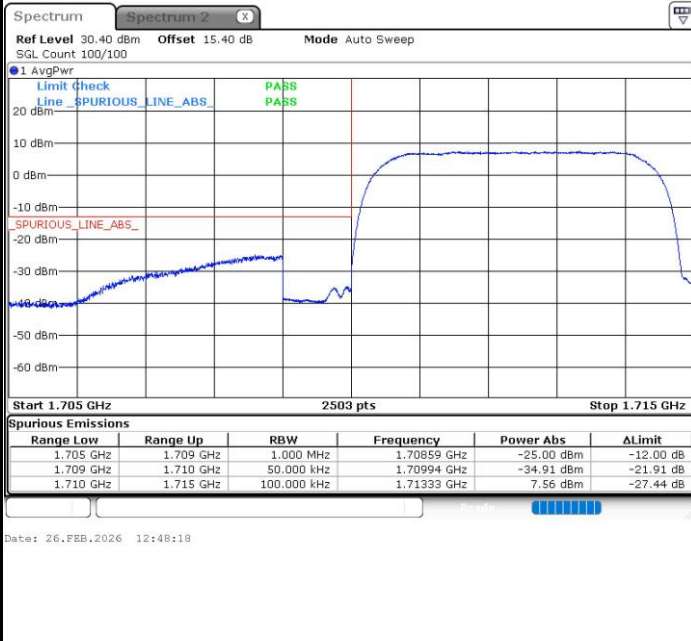



Conducted Spurious Emission

WCDMA Band V (RMC 12.2Kbps)

Lowest Channel

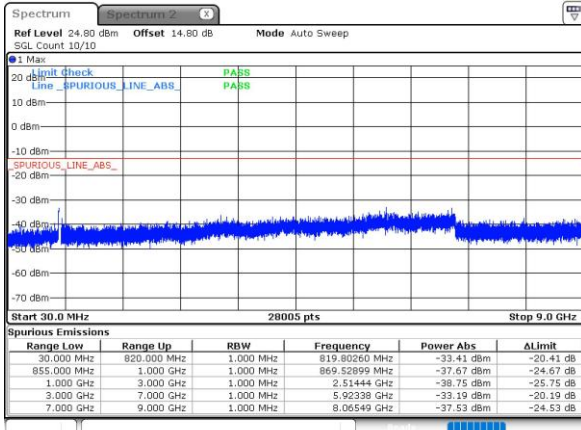

Date: 26.FEB.2026 13:39:13

WCDMA Band II (RMC 12.2Kbps)

Lowest Channel

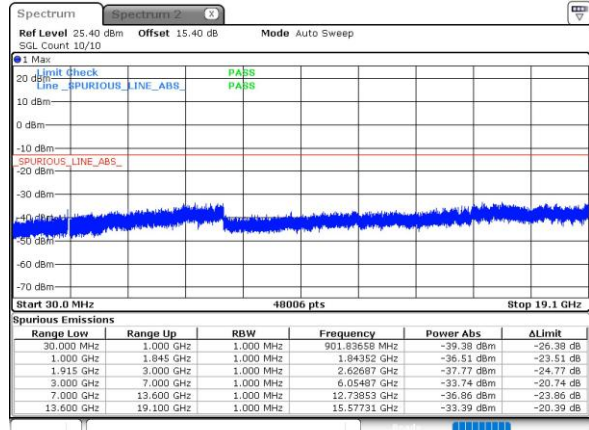

Date: 26.FEB.2026 12:31:51

Middle Channel

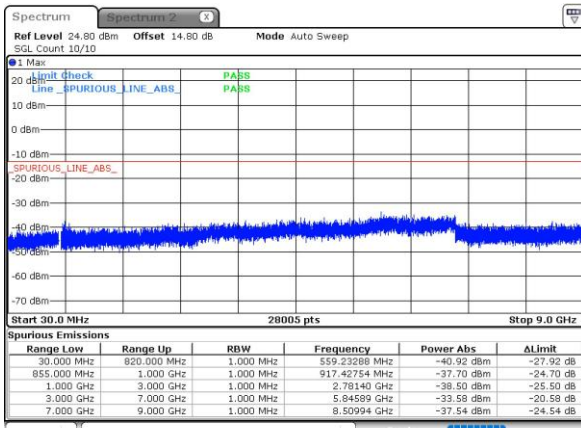

Date: 26.FEB.2026 13:41:16

Middle Channel

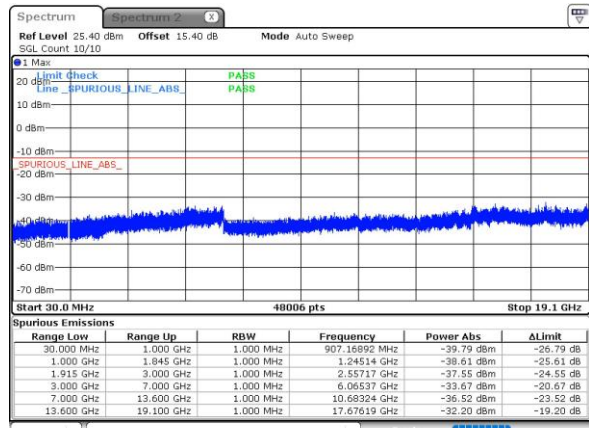

Date: 26.FEB.2026 12:34:13

Highest Channel

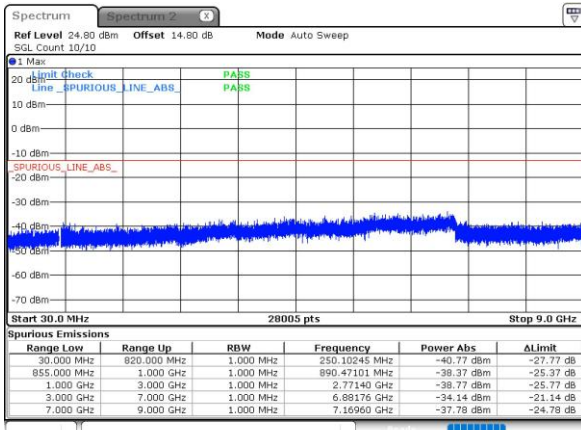

Date: 26.FEB.2026 13:45:57

Highest Channel

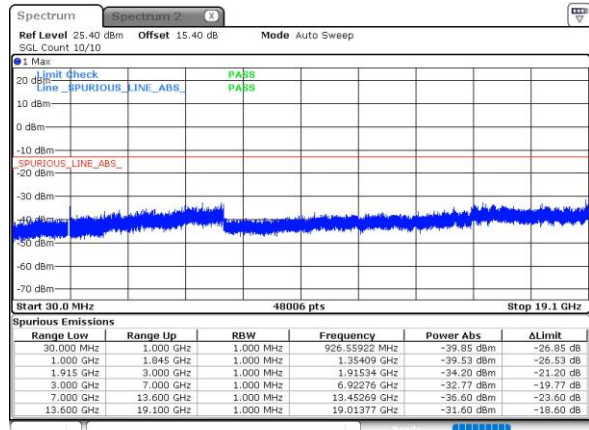

Date: 26.FEB.2026 12:37:18



WCDMA Band IV (RMC 12.2Kbps)

Lowest Channel

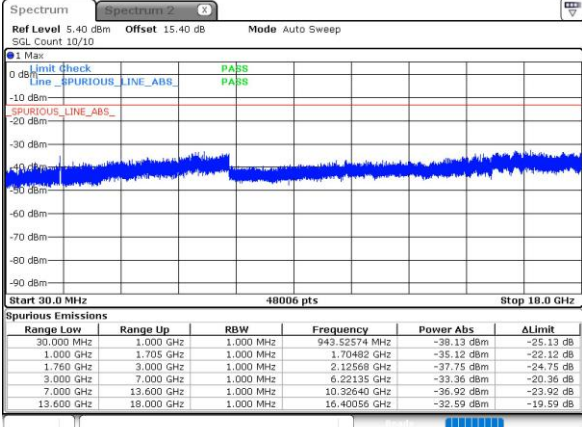

Date: 26.FEB.2026 12:52:25

Middle Channel

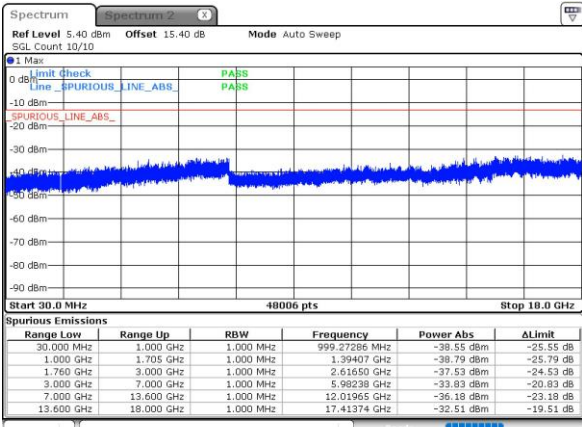

Date: 26.FEB.2026 12:54:28

Highest Channel

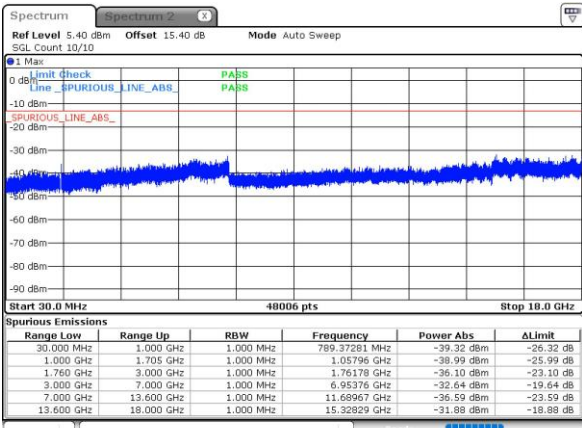

Date: 26.FEB.2026 12:57:47



Frequency Stability

Test Conditions	Middle Channel	WCDMA Band V (RMC 12.2Kbps)	Limit 2.5ppm
Temperature (°C)	Voltage (Volt)	Deviation (ppm)	Result
50	Normal Voltage	0.0041	PASS
40	Normal Voltage	0.0363	
30	Normal Voltage	0.0452	
20(Ref.)	Normal Voltage	0.0000	
10	Normal Voltage	0.0079	
0	Normal Voltage	0.0012	
-10	Normal Voltage	0.0478	
-20	Normal Voltage	0.0163	
-30	Normal Voltage	0.0349	
20	Maximum Voltage	0.0237	
20	Normal Voltage	0.0392	
20	Battery End Point	0.0097	

Test Conditions	Middle Channel	WCDMA Band II (RMC 12.2Kbps)	Limit Note 2.
Temperature (°C)	Voltage (Volt)	Deviation (ppm)	Result
50	Normal Voltage	0.0115	PASS
40	Normal Voltage	0.0169	
30	Normal Voltage	0.0178	
20(Ref.)	Normal Voltage	0.0000	
10	Normal Voltage	0.0122	
0	Normal Voltage	0.0095	
-10	Normal Voltage	0.0248	
-20	Normal Voltage	0.0436	
-30	Normal Voltage	0.0074	
20	Maximum Voltage	0.0129	
20	Normal Voltage	0.0392	
20	Battery End Point	0.0035	



Test Conditions	Middle Channel	WCDMA Band IV (RMC 12.2Kbps)	Limit Note 2.
Temperature (°C)	Voltage (Volt)	Deviation (ppm)	Result
50	Normal Voltage	0.0019	PASS
40	Normal Voltage	0.0163	
30	Normal Voltage	0.0052	
20(Ref.)	Normal Voltage	0.0000	
10	Normal Voltage	0.0044	
0	Normal Voltage	0.0048	
-10	Normal Voltage	0.0126	
-20	Normal Voltage	0.0311	
-30	Normal Voltage	0.0467	
20	Maximum Voltage	0.0018	
20	Normal Voltage	0.0062	
20	Battery End Point	0.0234	

Note:

1. Normal Voltage = 3.87V ; Battery End Point (BEP) =3.5V. ; Maximum Voltage =4.45V
2. The frequency fundamental emissions stay within the authorized frequency block based on the frequency deviation measured is small.



Appendix B. Test Results of Radiated Test

Radiated Spurious Emission

Test Engineer :	Simle Wang	Temperature :	22~23°C
		Relative Humidity :	40~42%

GSM850 (GSM)								
Channel	Frequency (MHz)	ERP (dBm)	Limit (dBm)	Over Limit (dB)	S.G. Power (dBm)	TX Cable loss (dB)	TX Antenna Gain (dBi)	Polarization (H/V)
Middle	1672	-47.95	-13	-34.95	-54.92	1.58	10.70	H
	2512	-47.67	-13	-34.67	-55.92	2.102	12.50	H
	3344	-44.67	-13	-31.67	-53.56	2.856	13.90	H
	1672	-42.31	-13	-29.31	-49.28	1.58	10.70	V
	2512	-50.39	-13	-37.39	-58.64	2.10	12.50	V
	3344	-47.51	-13	-34.51	-56.40	2.86	13.90	V

Remark: Spurious emissions within 30-1000MHz were found more than 20dB below limit line.

GSM850 (GPRS 1 Tx slots)								
Channel	Frequency (MHz)	ERP (dBm)	Limit (dBm)	Over Limit (dB)	S.G. Power (dBm)	TX Cable loss (dB)	TX Antenna Gain (dBi)	Polarization (H/V)
Middle	1672	-47.63	-13	-34.63	-54.60	1.58	10.70	H
	2512	-45.74	-13	-32.74	-53.99	2.102	12.50	H
	3344	-45.13	-13	-32.13	-54.02	2.856	13.90	H
	1672	-43.12	-13	-30.12	-50.09	1.58	10.70	V
	2512	-46.58	-13	-33.58	-54.83	2.10	12.50	V
	3344	-46.60	-13	-33.60	-55.49	2.86	13.90	V

Remark: Spurious emissions within 30-1000MHz were found more than 20dB below limit line.



GSM1900 (GSM)								
Channel	Frequency (MHz)	ERP (dBm)	Limit (dBm)	Over Limit (dB)	S.G. Power (dBm)	TX Cable loss (dB)	TX Antenna Gain (dBi)	Polarization (H/V)
Middle	3765	-42.14	-13	-29.14	-54.40	2.641	14.90	H
	5640	-49.61	-13	-36.61	-61.47	2.94	14.80	H
	7515	-48.98	-13	-35.98	-58.75	3.39	13.16	H
	9405	-42.44	-13	-29.44	-52.92	4.00	14.48	H
	3765	-47.16	-13	-34.16	-59.42	2.64	14.90	V
	5640	-53.06	-13	-40.06	-64.92	2.94	14.80	V
	7515	-51.59	-13	-38.59	-61.36	3.39	13.16	V
	9405	-42.35	-13	-29.35	-52.83	4.00	14.48	V

Remark: Spurious emissions within 30-1000MHz were found more than 20dB below limit line.

GSM1900 (GPRS 1 Tx slots)								
Channel	Frequency (MHz)	ERP (dBm)	Limit (dBm)	Over Limit (dB)	S.G. Power (dBm)	TX Cable loss (dB)	TX Antenna Gain (dBi)	Polarization (H/V)
Middle	3765	-43.67	-13	-30.67	-55.93	2.641	14.90	H
	5640	-51.44	-13	-38.44	-63.30	2.94	14.80	H
	7515	-49.84	-13	-36.84	-59.61	3.39	13.16	H
	9405	-43.21	-13	-30.21	-53.69	4.00	14.48	H
	3765	-46.32	-13	-33.32	-58.58	2.64	14.90	V
	5640	-54.85	-13	-41.85	-66.71	2.94	14.80	V
	7515	-51.90	-13	-38.90	-61.67	3.39	13.16	V
	9405	-41.05	-13	-28.05	-51.53	4.00	14.48	V

Remark: Spurious emissions within 30-1000MHz were found more than 20dB below limit line.

WCDMA Band V(RMC 12.2Kbps)								
Channel	Frequency (MHz)	ERP (dBm)	Limit (dBm)	Over Limit (dB)	S.G. Power (dBm)	TX Cable loss (dB)	TX Antenna Gain (dBi)	Polarization (H/V)
Middle	1672	-62.01	-13	-49.01	-74.27	2.641	14.90	H
	2512	-57.74	-13	-44.74	-69.60	2.94	14.80	H
	3344	-57.59	-13	-44.59	-67.36	3.39	13.16	H
	1672	-60.99	-13	-47.99	-73.25	2.64	14.90	V
	2512	-56.55	-13	-43.55	-68.41	2.94	14.80	V
	3344	-57.01	-13	-44.01	-66.78	3.39	13.16	V

Remark: Spurious emissions within 30-1000MHz were found more than 20dB below limit line.



WCDMA Band II(RMC 12.2Kbps)								
Channel	Frequency (MHz)	ERP (dBm)	Limit (dBm)	Over Limit (dB)	S.G. Power (dBm)	TX Cable loss (dB)	TX Antenna Gain (dBi)	Polarization (H/V)
Middle	3765	-54.72	-13	-41.72	-66.98	2.641	14.90	H
	5640	-54.73	-13	-41.73	-66.59	2.94	14.80	H
	7515	-51.56	-13	-38.56	-61.33	3.39	13.16	H
	3765	-53.57	-13	-40.57	-65.83	2.64	14.90	V
	5640	-55.33	-13	-42.33	-67.19	2.94	14.80	V
	7515	-51.53	-13	-38.53	-61.30	3.39	13.16	V

Remark: Spurious emissions within 30-1000MHz were found more than 20dB below limit line.

WCDMA Band IV(RMC 12.2Kbps)								
Channel	Frequency (MHz)	ERP (dBm)	Limit (dBm)	Over Limit (dB)	S.G. Power (dBm)	TX Cable loss (dB)	TX Antenna Gain (dBi)	Polarization (H/V)
Middle	3465	-56.81	-13	-43.81	-67.55	2.604	13.34	H
	5190	-54.30	-13	-41.30	-64.81	3.011	13.52	H
	6930	-53.63	-13	-40.63	-63.83	3.271	13.47	H
	3465	-57.22	-13	-44.22	-67.96	2.604	13.34	V
	5190	-54.37	-13	-41.37	-64.88	3.011	13.52	V
	6930	-53.56	-13	-40.56	-63.76	3.271	13.47	V

Remark: Spurious emissions within 30-1000MHz were found more than 20dB below limit line.